

Dr. Eckhard Pehlke, Lars Eskildsen | BBZ Dithmarschen | Meldorf | Germany

## Verification of the physical model in computer games by motion analysis

### Virtual vs. Real ?

The simulated motion in virtual computer games - is this somehow connected to reality?

Analyzing throwing motion as used in computer games is one approach to get an answer to this question.

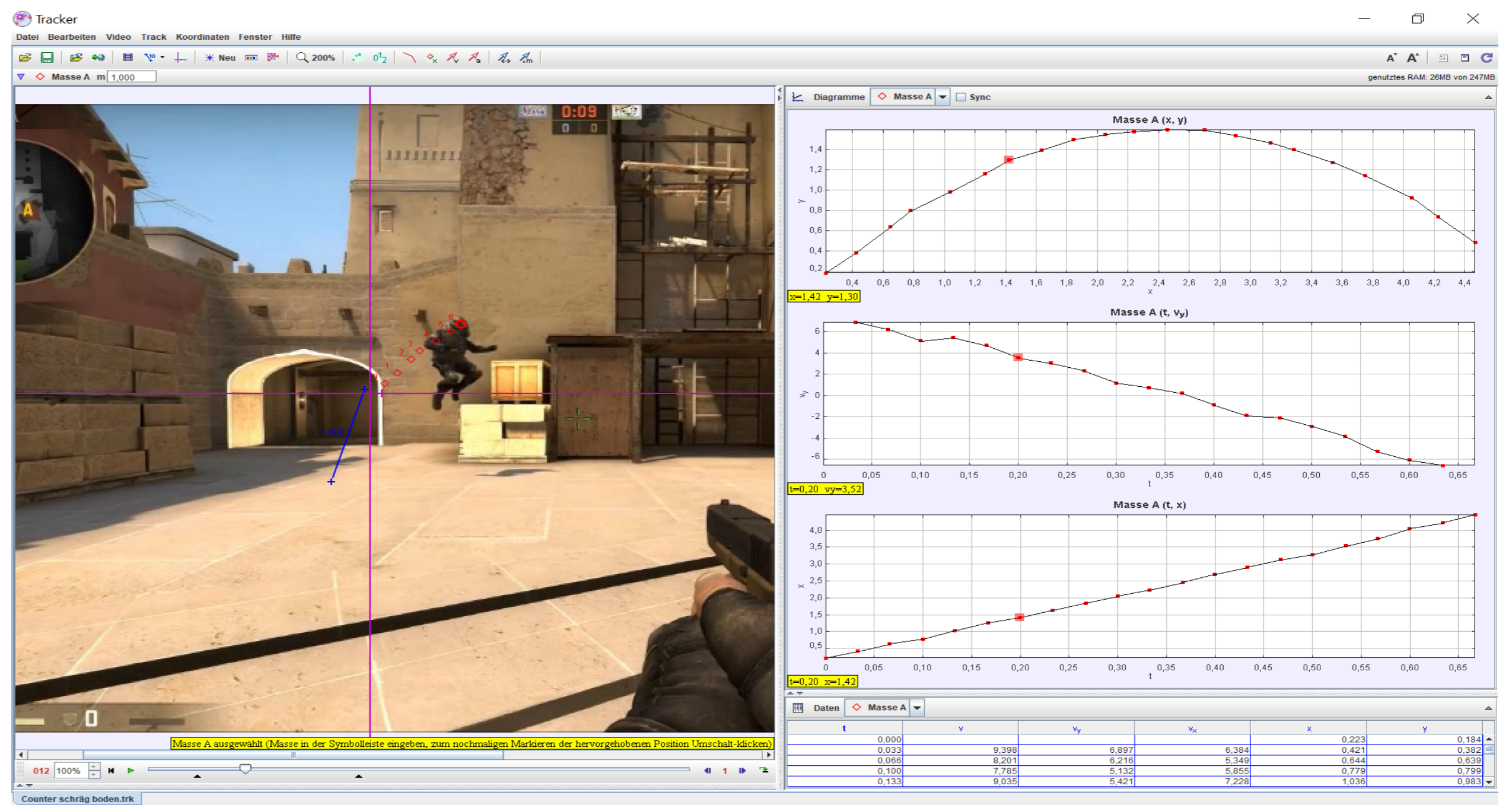

Step one : Recording a suitable part of a computer game using a **screen recorder**

Step two : Defining a coordinate system and a length scale in the **video analysis software**

Step three : Setting the measurement points

Step four : Evaluating graphs / comparing with the real model

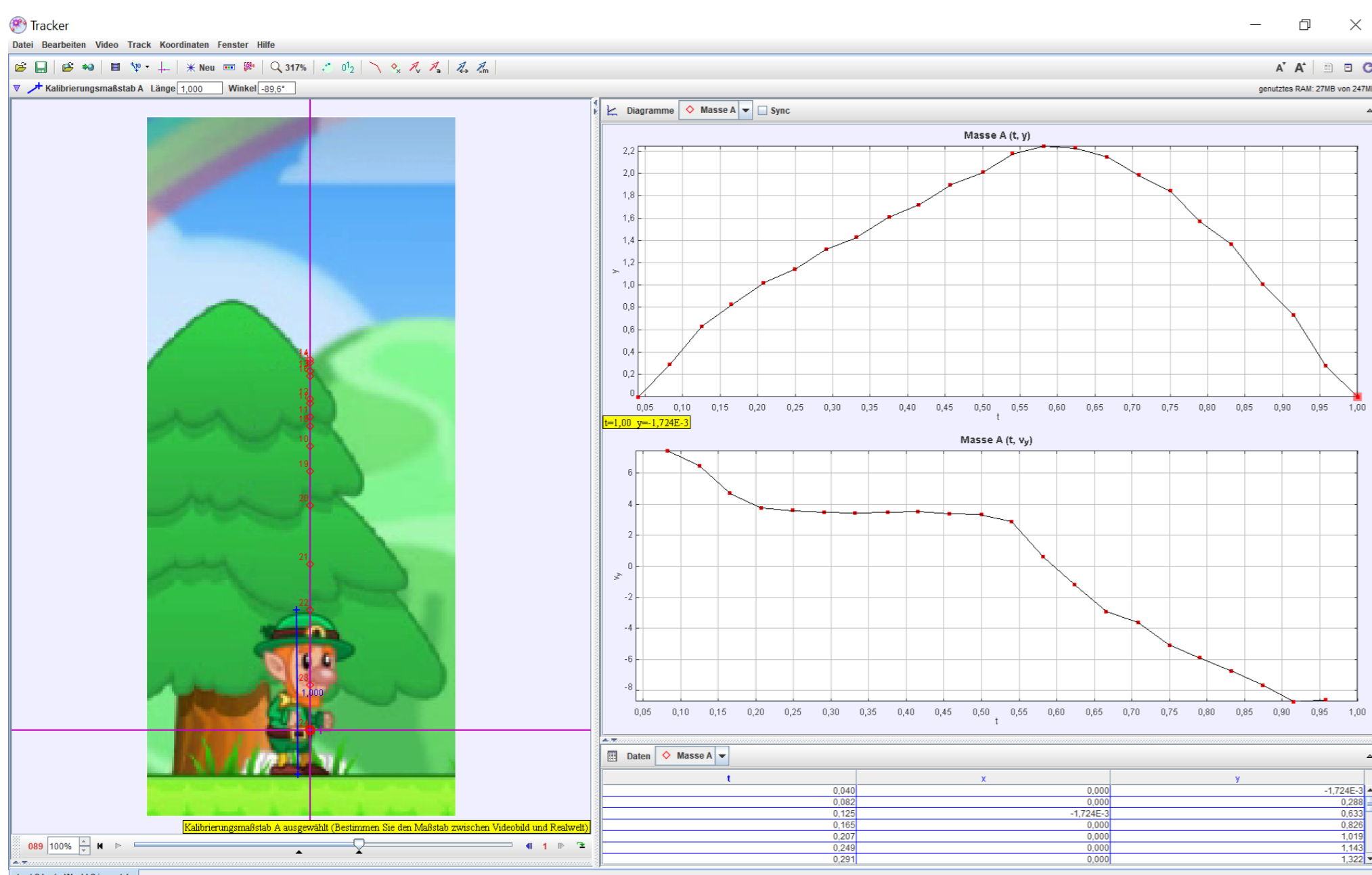

**Virtual**

Upward motion:  $g = 0 \text{ m/s}^2$   
Downward motion:  $g = 11 \text{ m/s}^2$

vs.

**Real**

Upward motion:  $g = 9,6 \text{ m/s}^2$   
Downward motion:  $g = 9,86 \text{ m/s}^2$

**Result:**

- most games show the typical trajectories
- gravitational acceleration in most games is too large:  $g \approx 20 \text{ m/s}^2$

test  
now

Dr. Eckhard Pehlke, Lars Eskildsen | BBZ Dithmarschen | Meldorf | Germany

## Verification of the physical model in computer games by motion analysis

### Virtual vs. Real ?

The simulated motion in virtual computer games - is this somehow connected to reality?

Analyzing throwing motion as used in computer games is one approach to get an answer to this question.

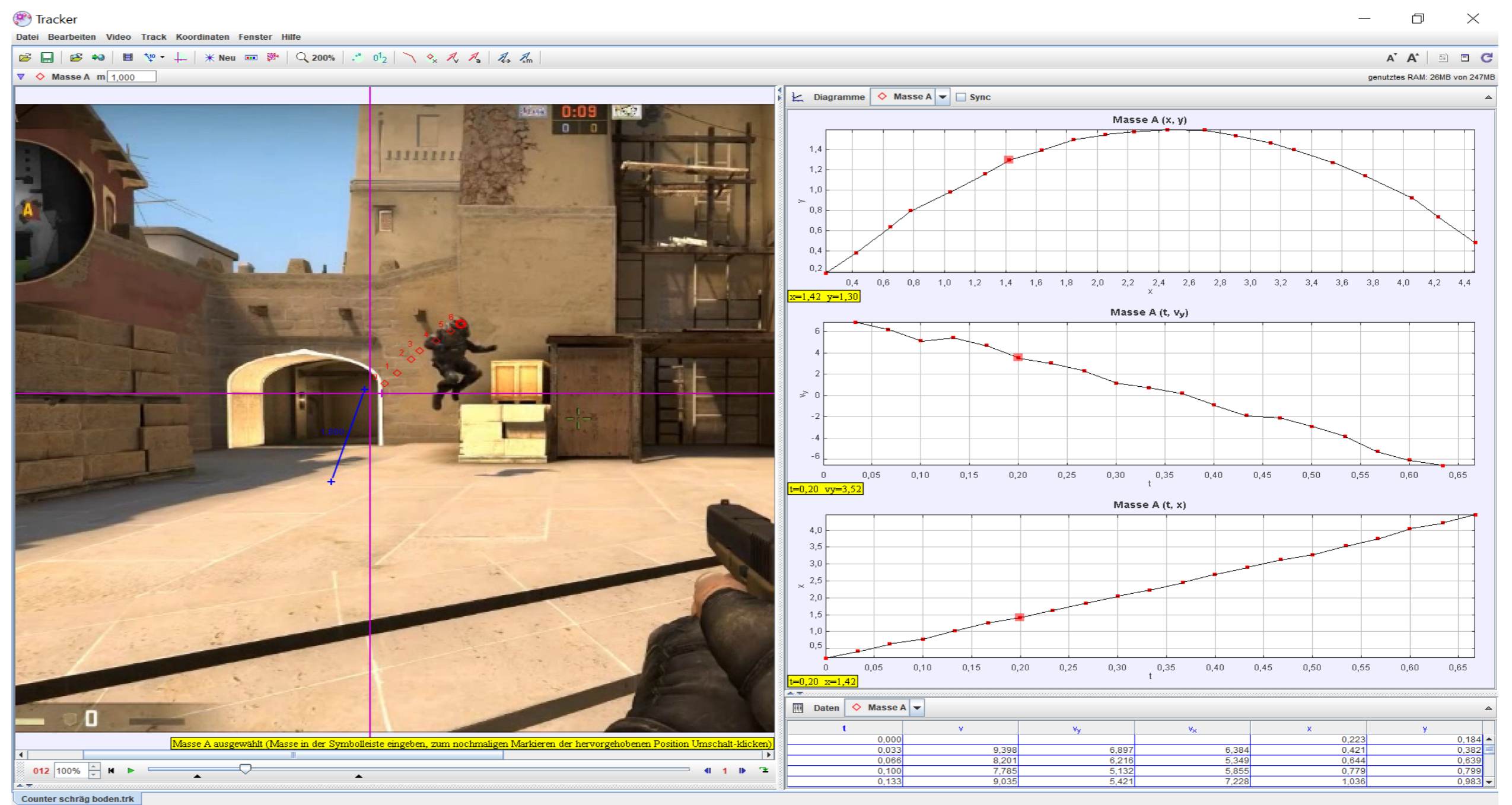

Step one : Recording a suitable part of a computer game using a **screen recorder**

Step two : Defining a coordinate system and a length scale in the **video analysis software**

Step three : Setting the measurement points

Step four : Evaluating graphs / comparing with the real model

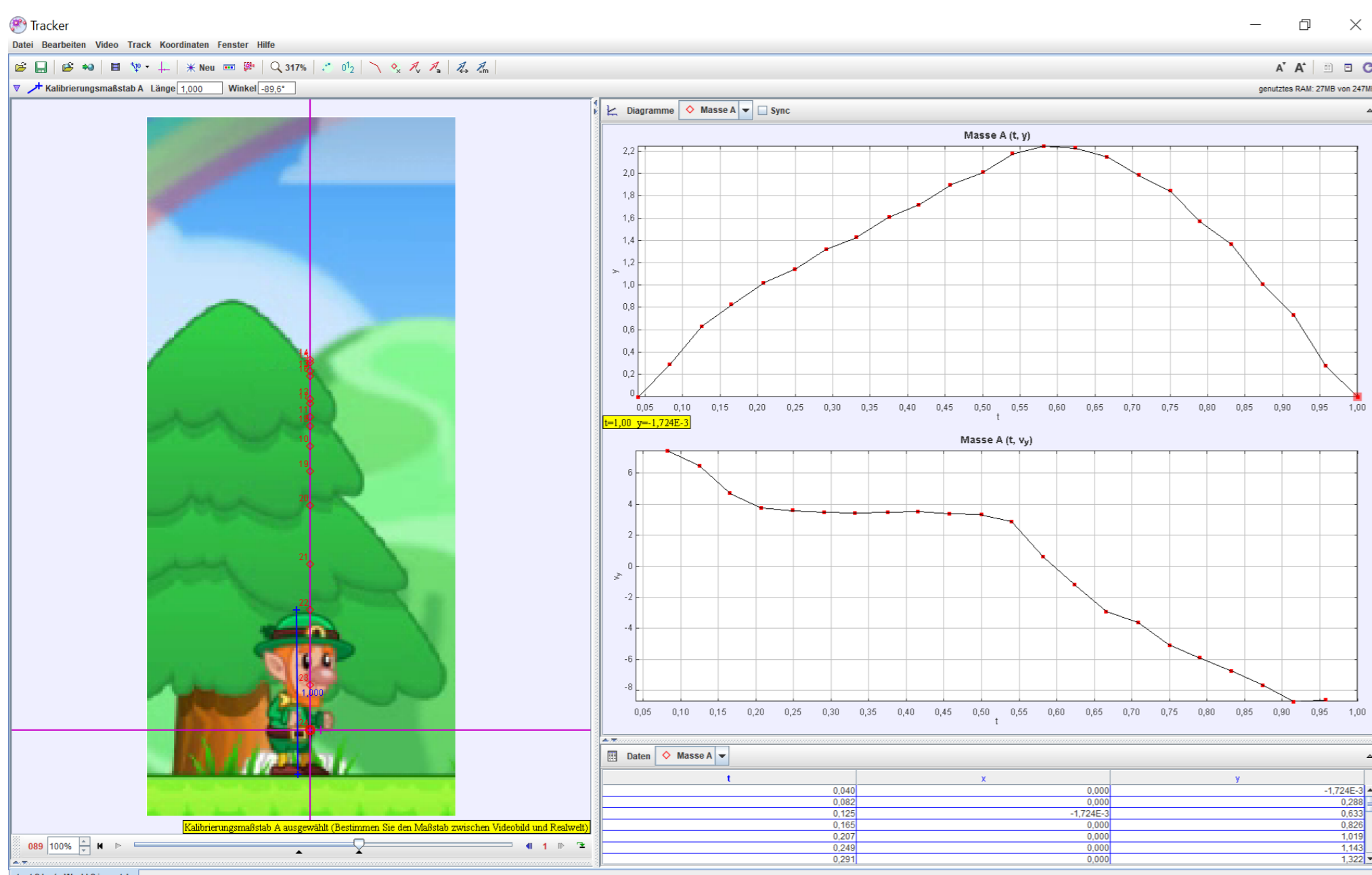

**Virtual**

Upward motion:  $g = 0 \text{ m/s}^2$   
Downward motion:  $g = 11 \text{ m/s}^2$

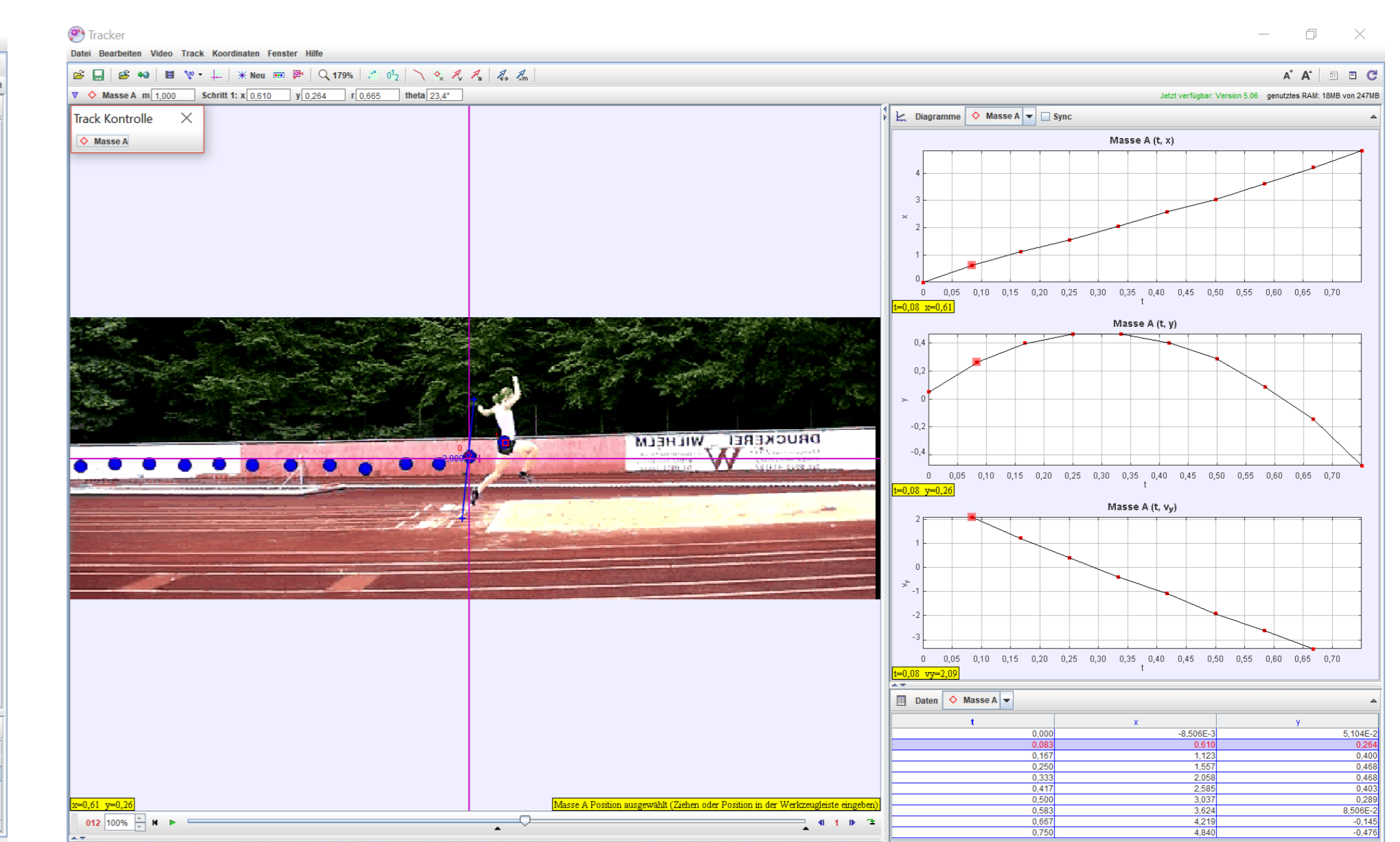

vs.

**Real**

Upward motion:  $g = 9,6 \text{ m/s}^2$   
Downward motion:  $g = 9,86 \text{ m/s}^2$

**Result:**

- most games show the typical trajectories
- gravitational acceleration in most games is too large:  $g \approx 20 \text{ m/s}^2$

test  
now

Venczel Borbély | Piarista Gimnázium és Kollégium | Vác | Hungary

## Simple experiments on breadboard in the classroom and at home, applied to education of electricity and to other areas of physics

The relatively inexpensive\* "electricity package" presented here is excellent for teaching electricity, it can be easily supplemented by new parts at any time and it is useable in other areas of physics (optics, thermodynamics, etc.). It also opens up the possibility of learning the use of microcontrollers (Arduino, micro:bit, etc.) to make measurements and experiments even more interesting.

### Experiments in electricity

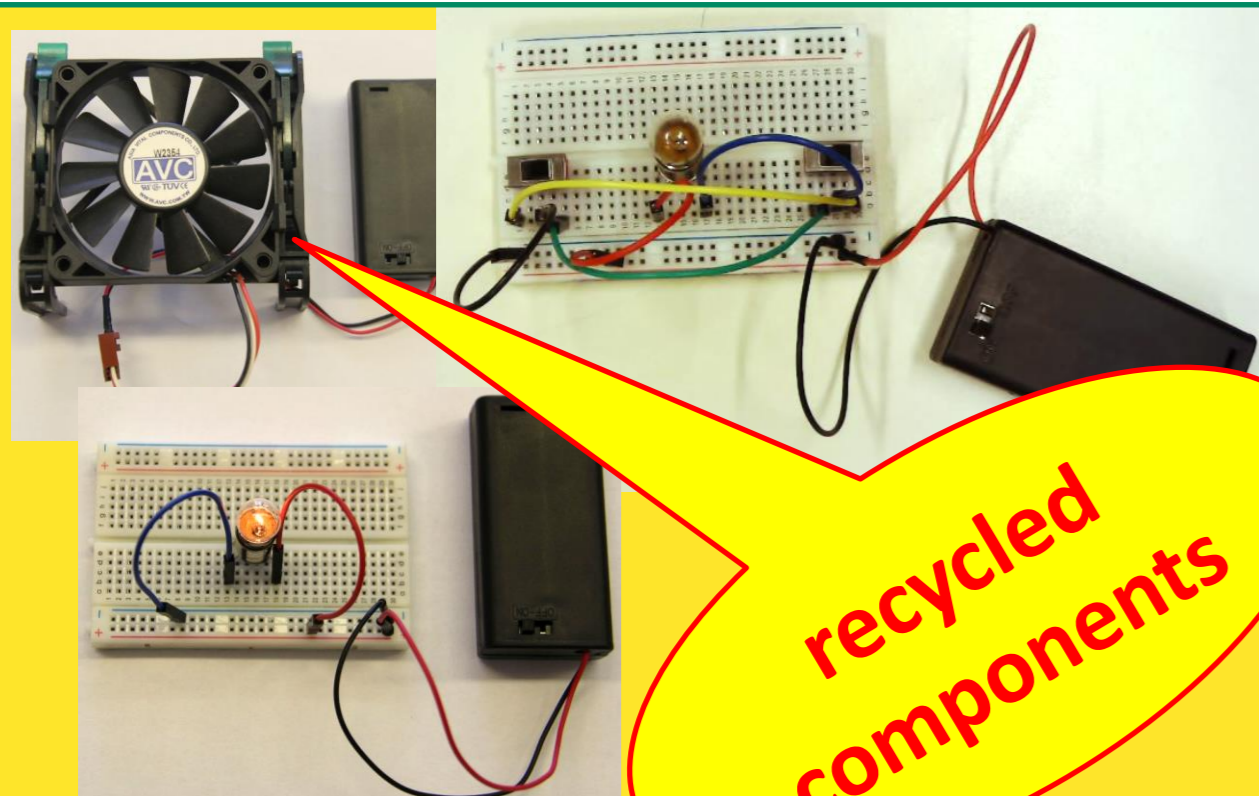

recycled components

Simple circuits, alternative switching

### Resistance measurement

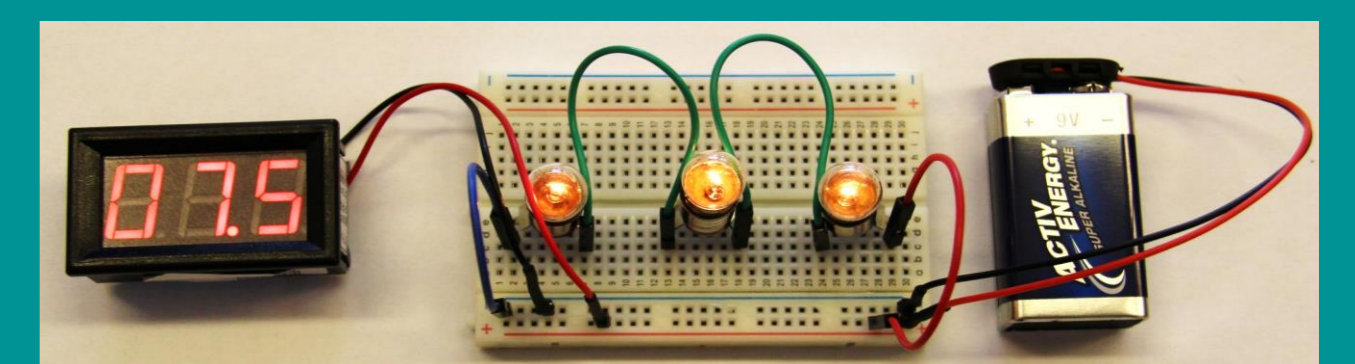
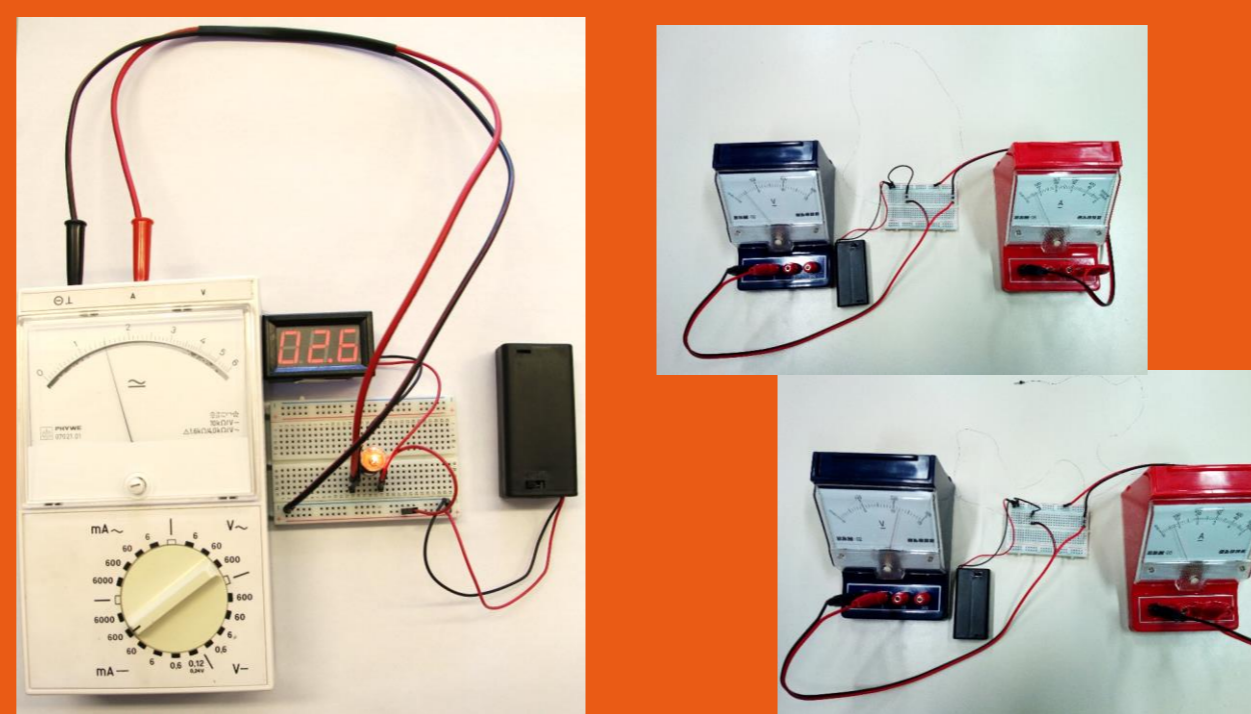

Serial and parallel connection

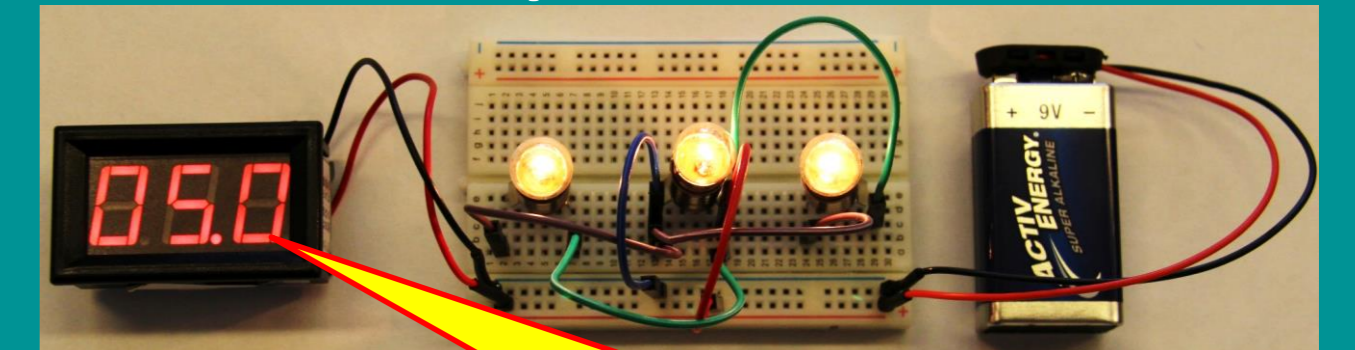

cheap parts & accessories

### Today's electrical devices: LED & transistor

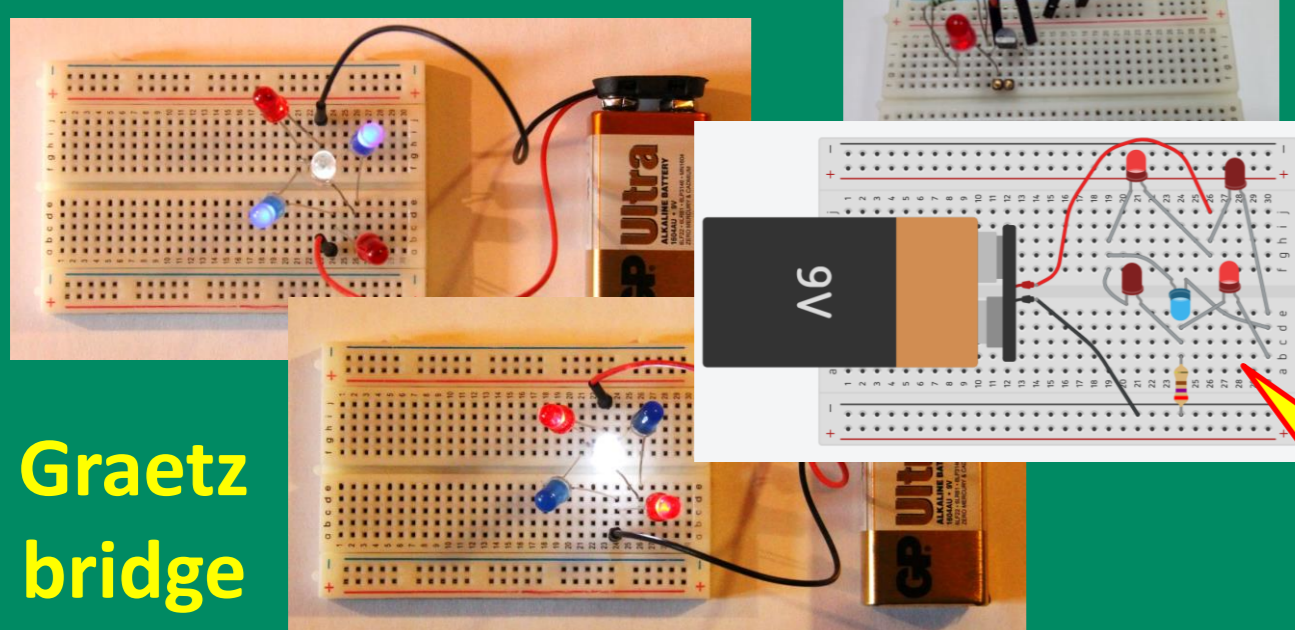

Graetz bridge

easy to expand & complete

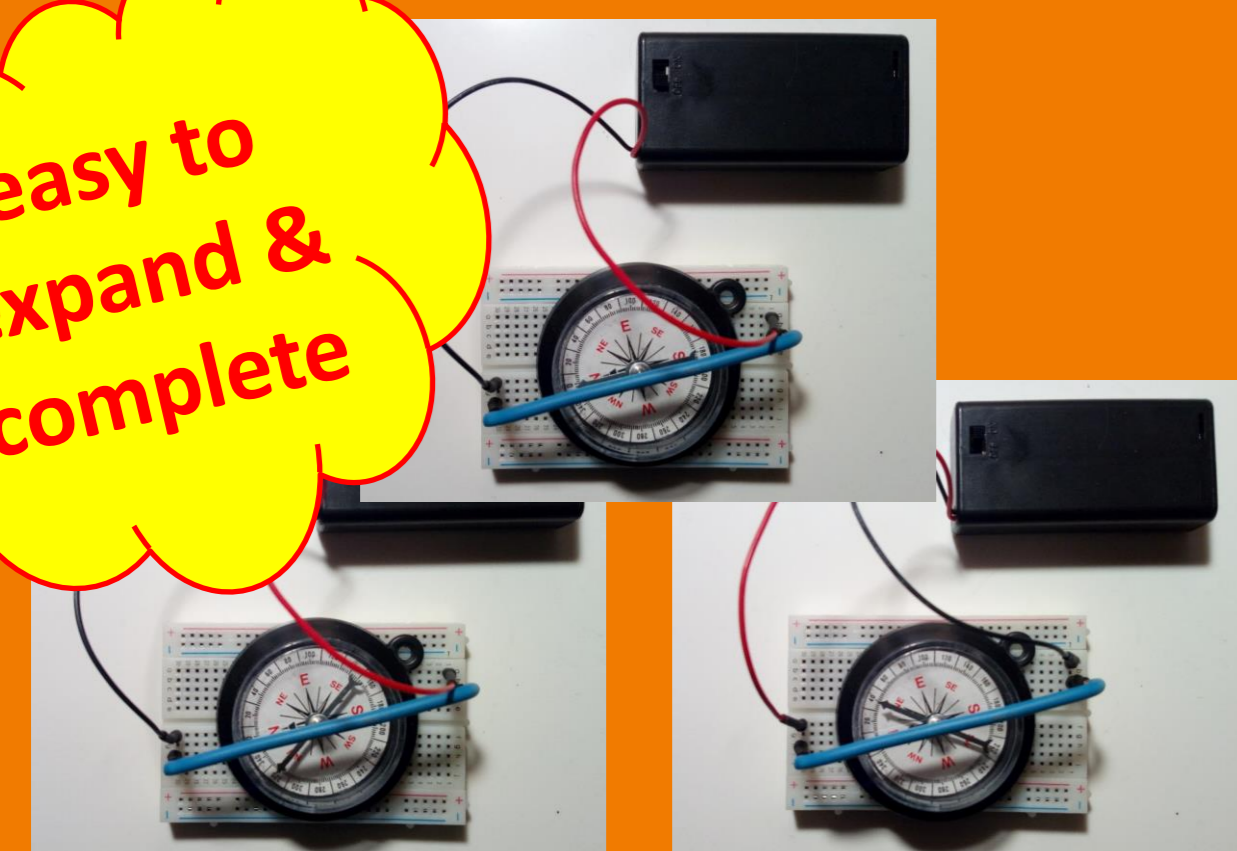

Oersted's experiment

cheap: 1 pack ~ 25 € with instruments  
multicolored electricity:  
playful physics lessons  
theory → practice  
recycling: semi-exhausted batteries,  
old electrical components  
experimenting at home:  
the students can also purchase it

### Voltage divider

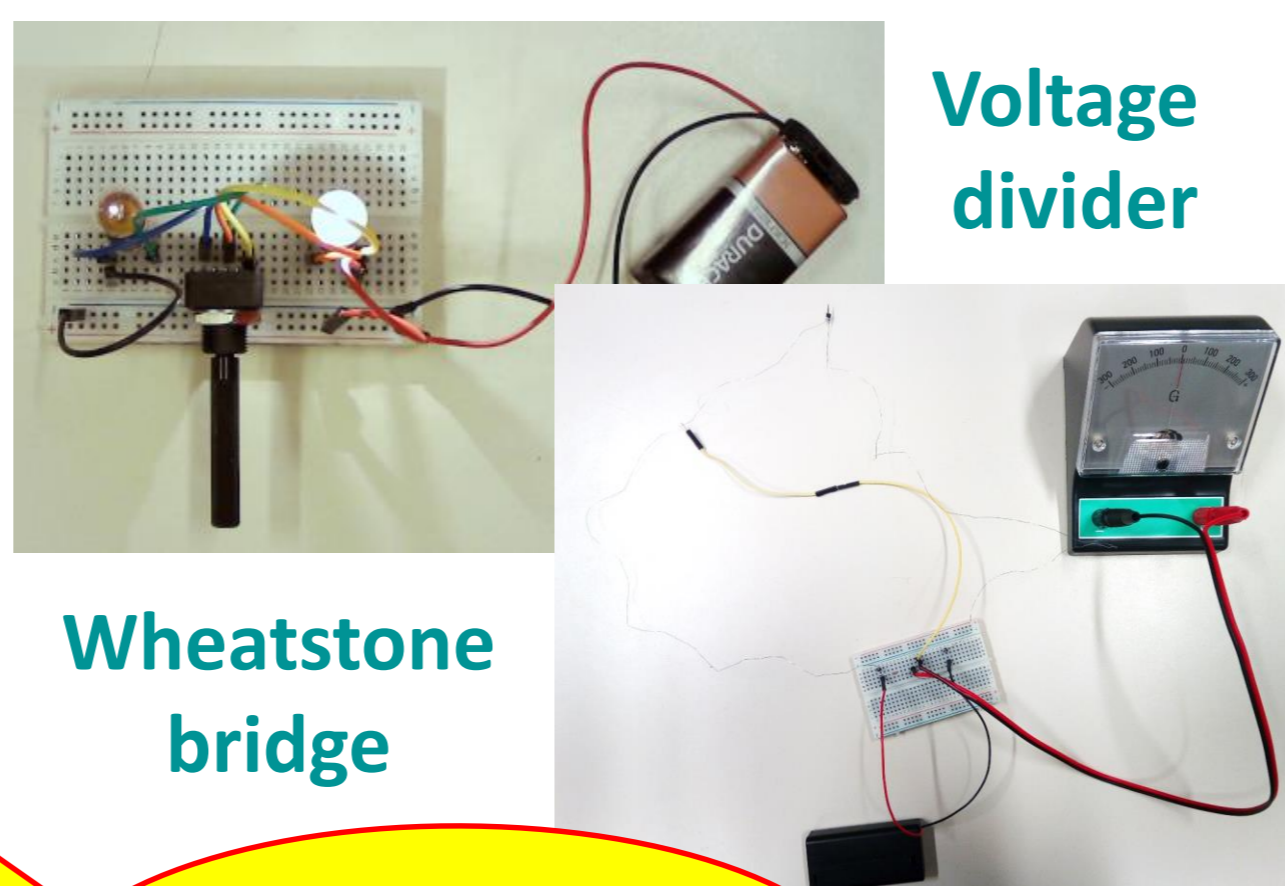

Wheatstone bridge

TIN with KER CAD & fritzing

### Modern Physics: Determination of Planck constant

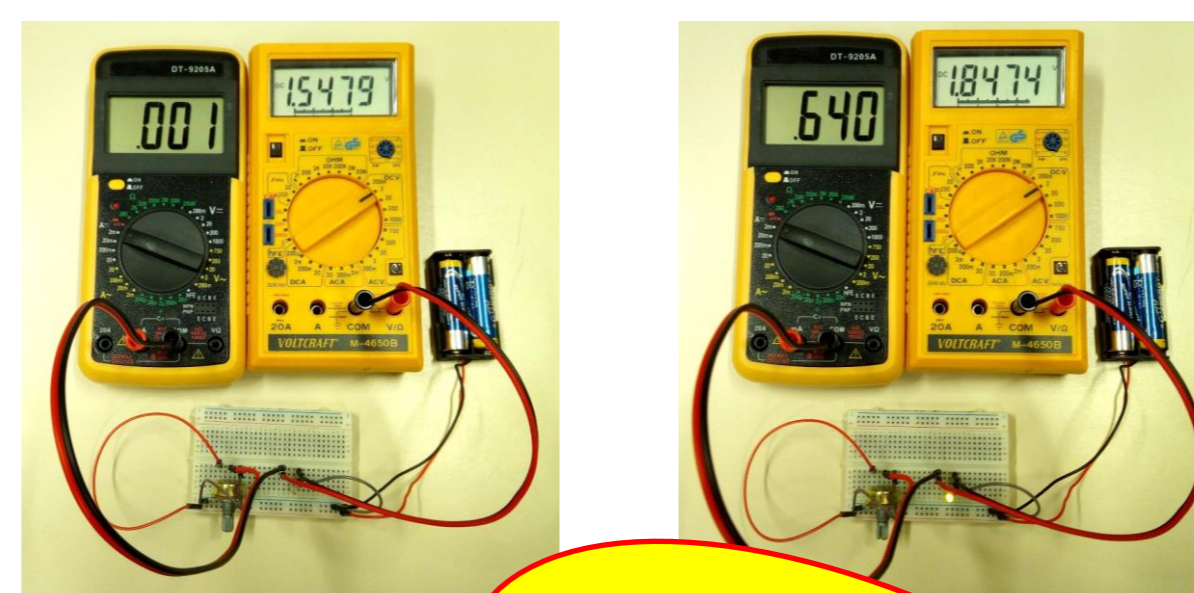

first step towards microcontrollers

### Thermodynamics: Thermal interaction using thermistor

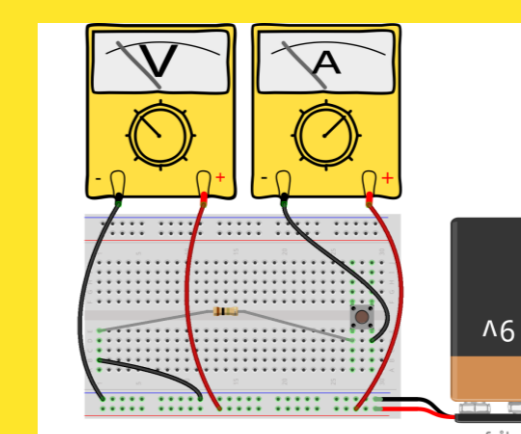
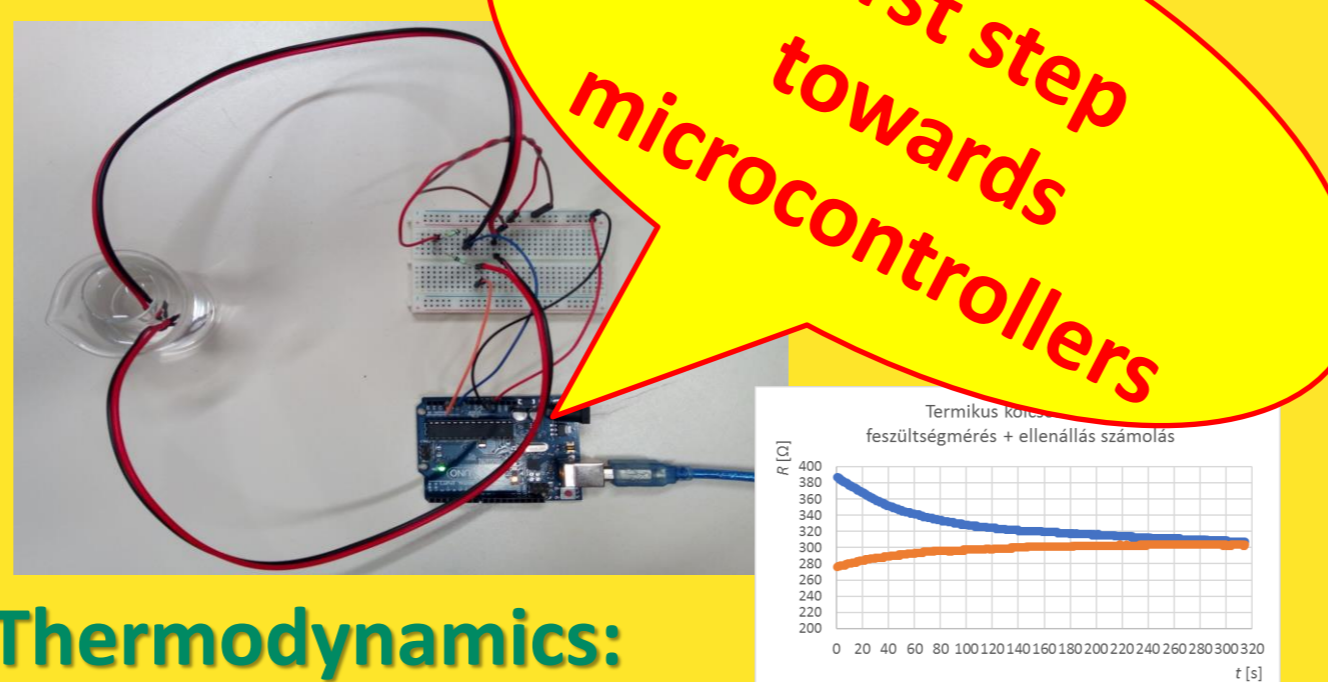

Parameters of the Power Source

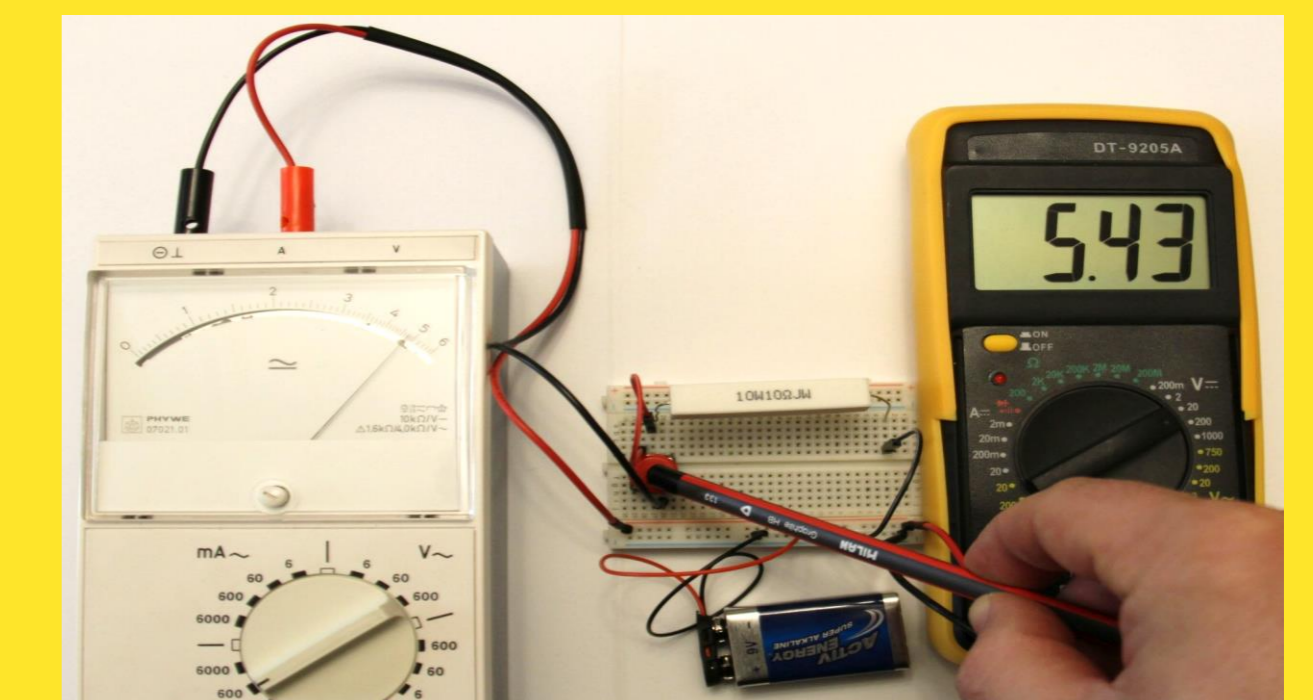

### In other areas of physics

#### Optics: Examination of diffraction

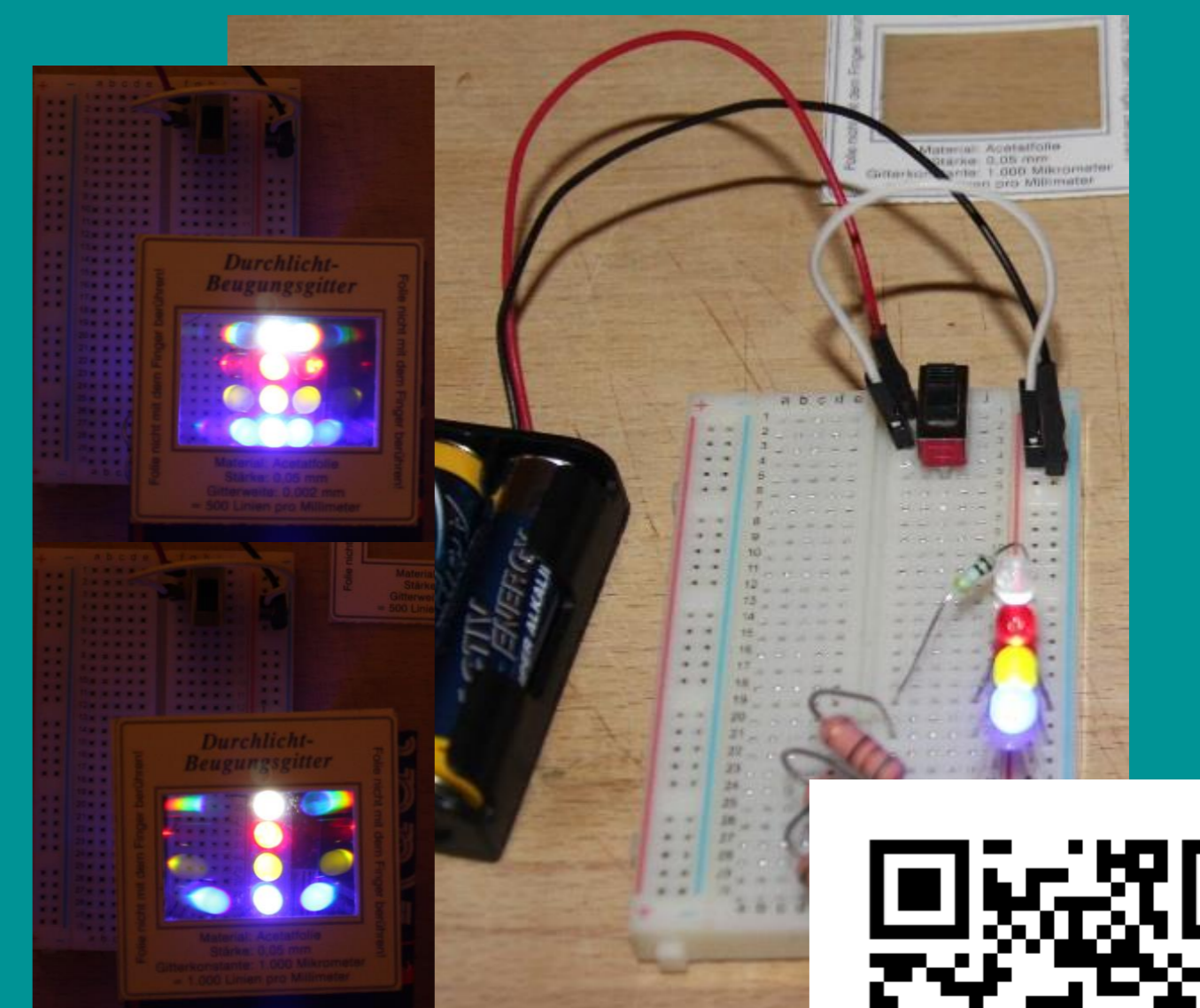

\*15-20 packages - sufficient for a whole class - can be purchased from the price of a commercially available electricity learning kit

Francesca Butturini, Gordon Kennedy | Liceo Educandato agli Angeli | Verona | Italy

## Oranges and Lemons...

### Chemistry of limonene, a chiral molecule



#### 1. EXTRACTION

of limonene from exocarp of lemons and oranges via steam distillation.

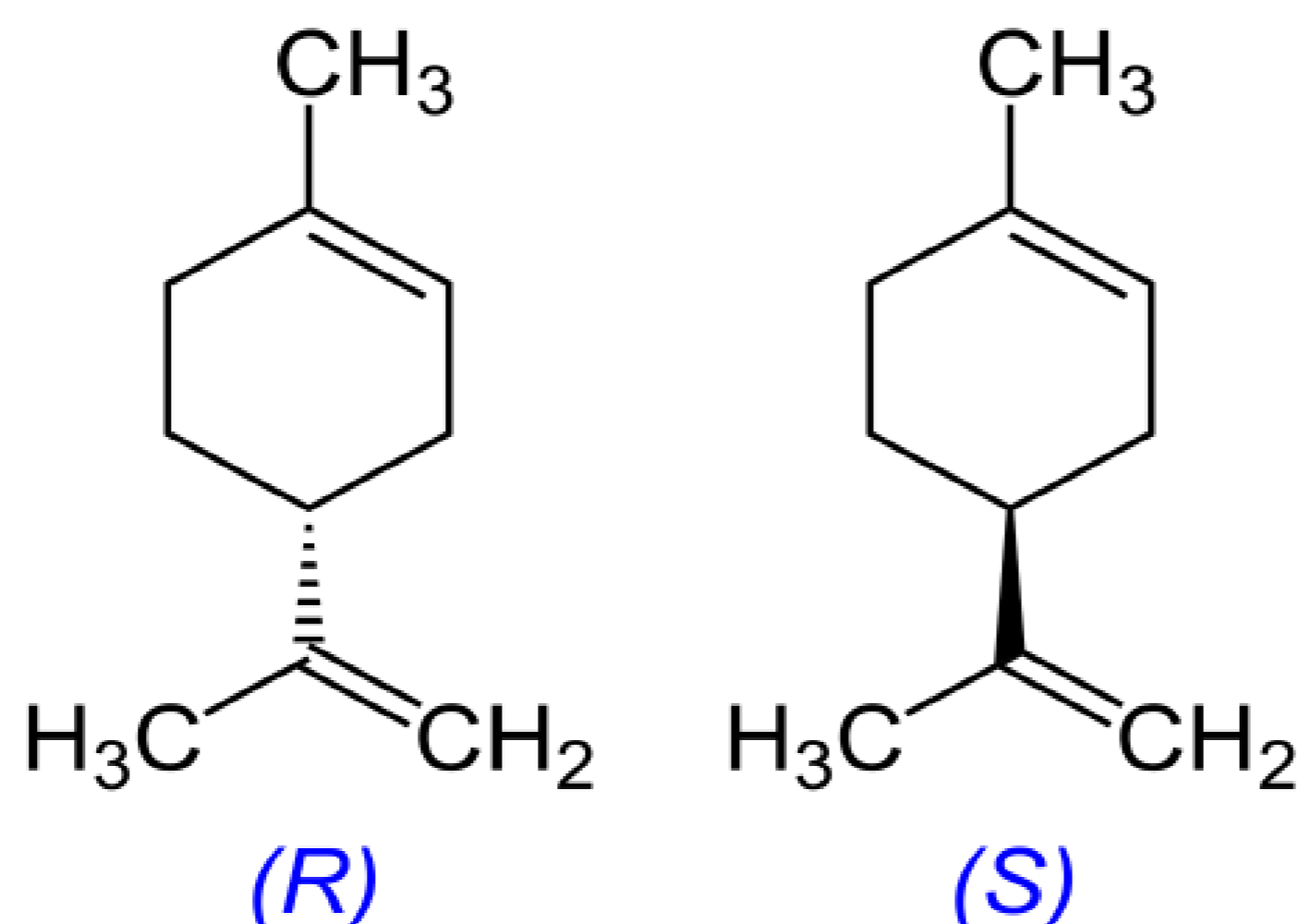

#### 2. TITRATION

of the mixture with solutions of different concentrations of  $\text{KMnO}_4$  to determine the presence of double bonds characteristic of isoprenic derivatives as well as provide an estimate of the amount of limonene.

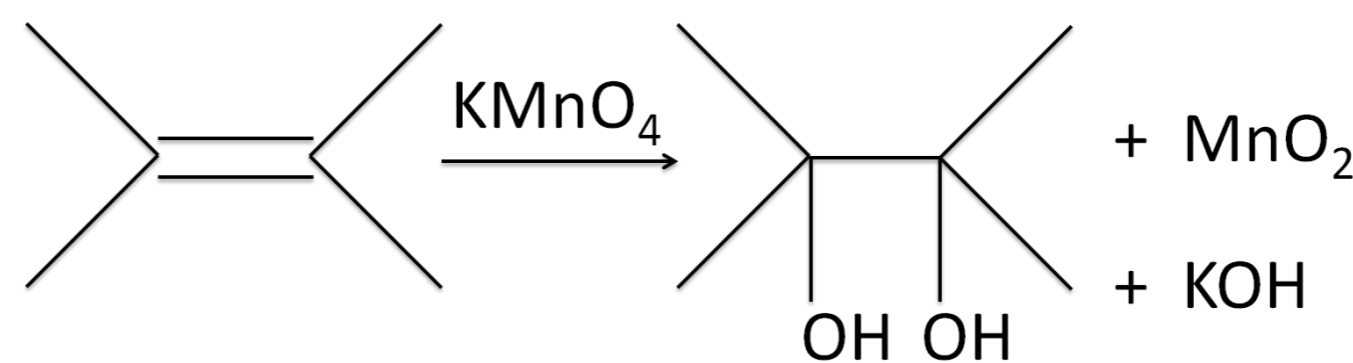

#### 3. BUILD A POLARIMETER

from recycled materials to semi-quantitatively measure the rotatory power of the enantiomers of limonene:  $+123^\circ$  R-limonene or  $-123^\circ$  S-limonene.



#### 4. BUILD A COLORIMETER

using a simple circuit diagram and adapting it to our needs for the determination of the concentration of limonene in the distillate.

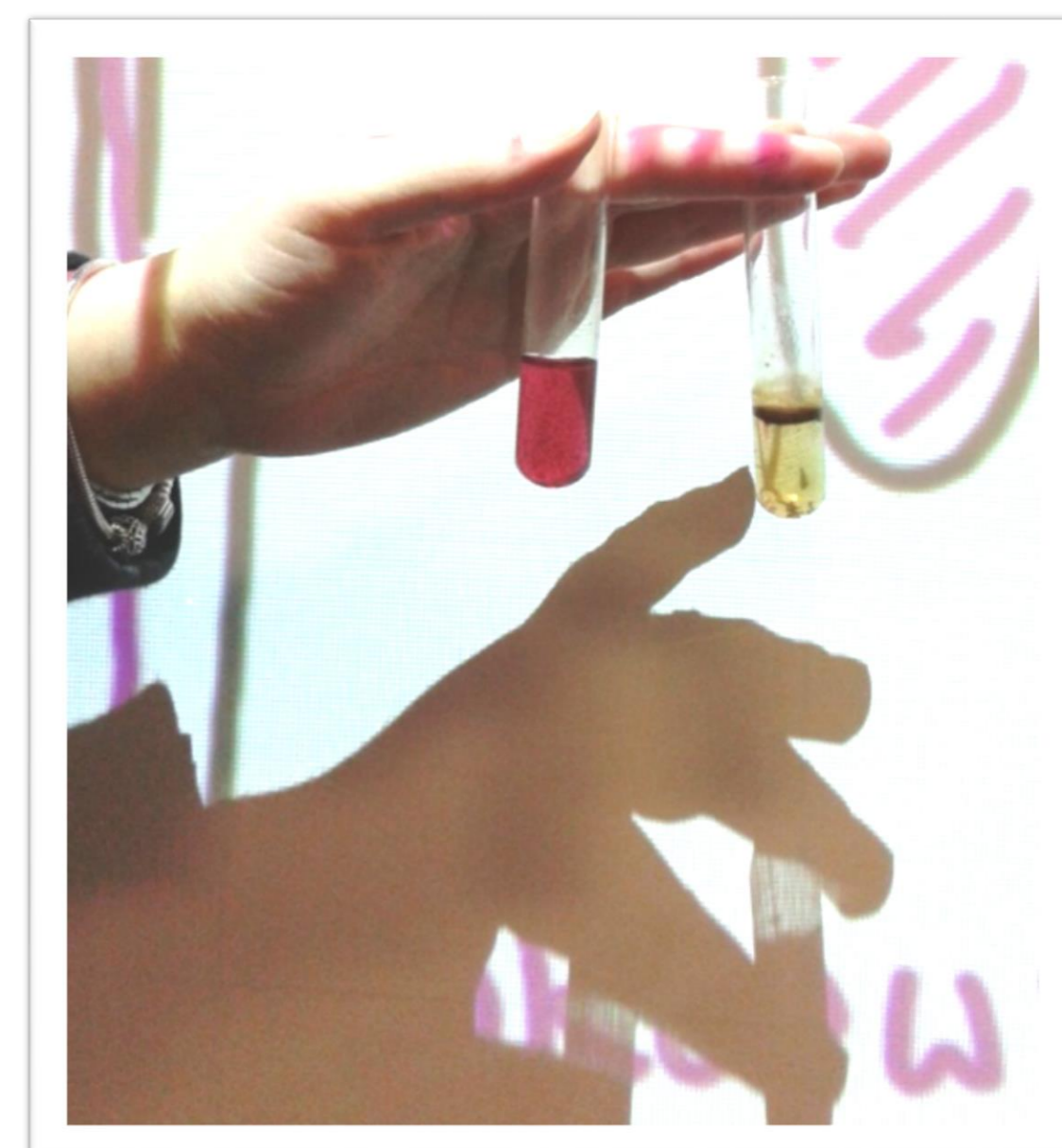
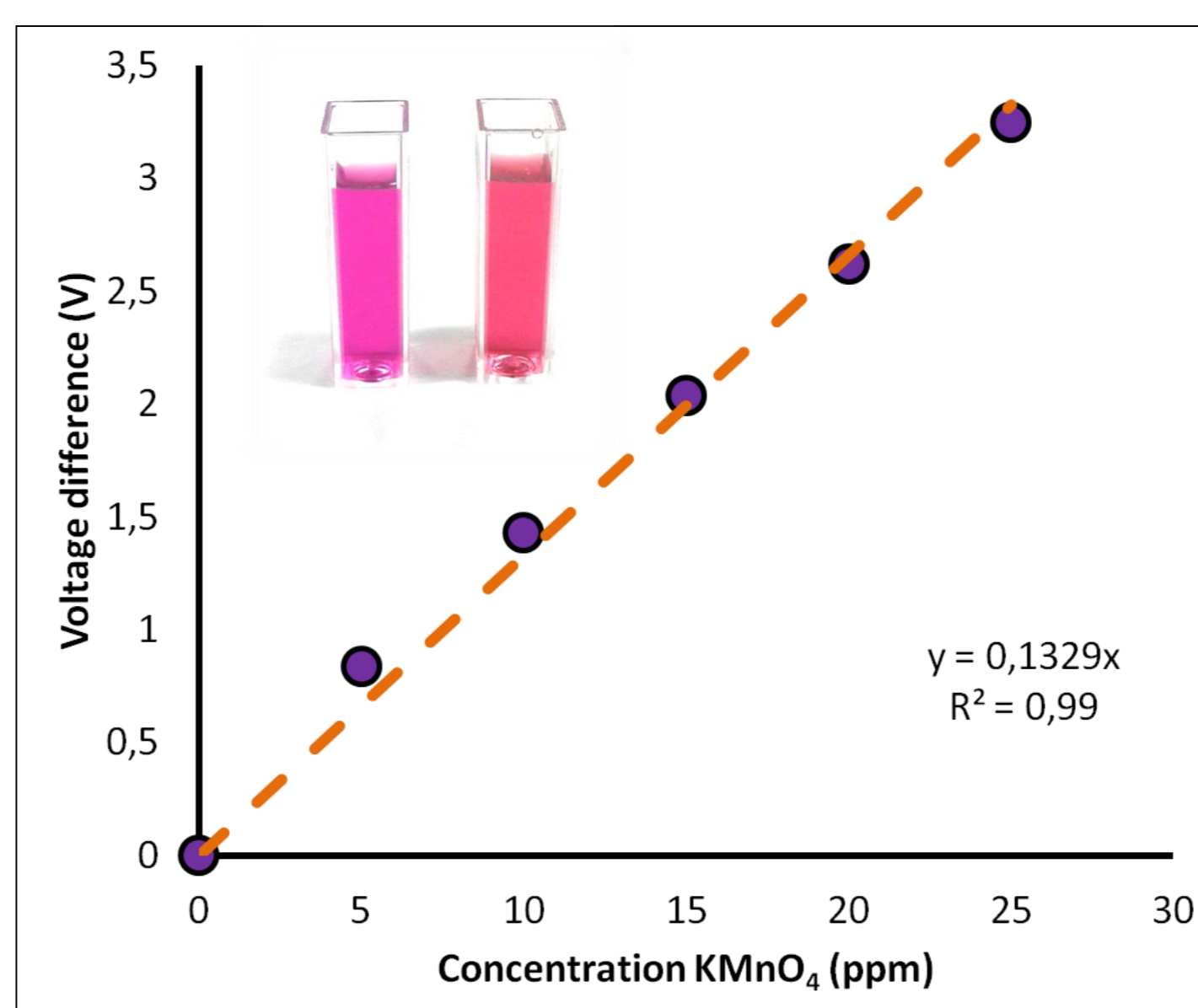

*An exploration of the chemistry of oranges and lemons for less than five farthings using yoghurt pots, pans, 3D cinema glasses and a black box!*

Maria Teresa Gallo | Secondary School F. Corridoni | Fogliano Redipuglia (GO) | Italy

## How much maths there is in fruit and vegetables!

A "sweet" approach to area and volume concepts and scale change

It's often easy to estimate the area of a flat surface, but most things in the world are not flat. This activity gives students the opportunity to think about areas in terms of everyday items such as fruits and vegetables. **Let's measure lengths, diameters, volumes and peel areas of fruit!**



From there, they can apply their learning to trees and animals, even to their friends.

**Let's measure our palm's surface area!**

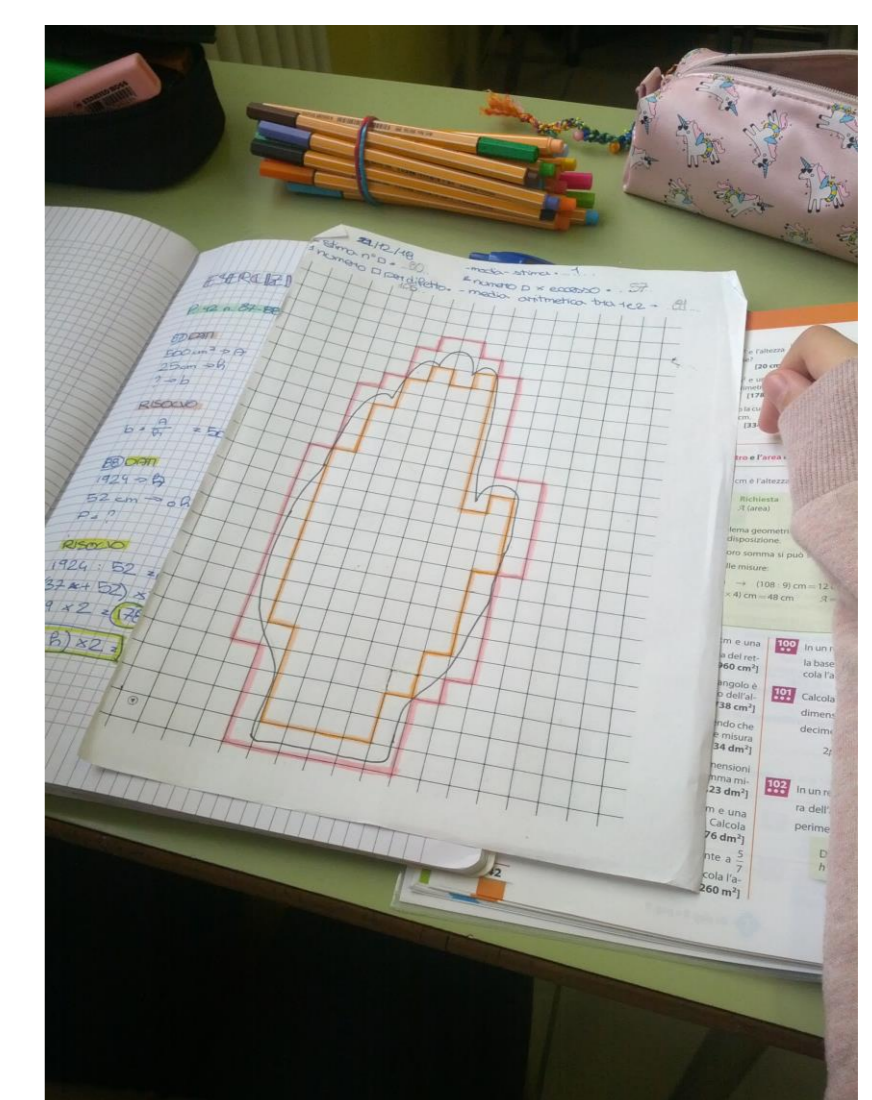

If we have similarly shaped fruits and various size vegetables we can see how **areas and volumes grow at very different rates**. We can show a model of this concept by using cubes with various edge lengths.

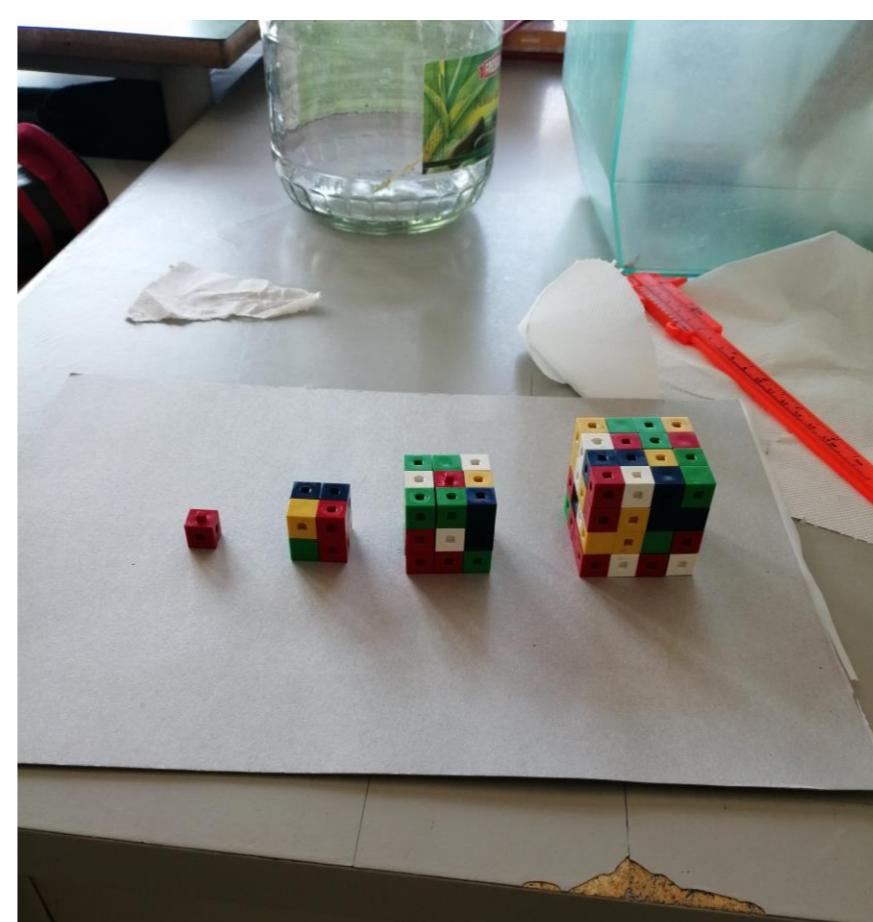

Length of edge (cm)	Area of base (cm <sup>2</sup> )	Area of total surface (cm <sup>2</sup> )	Volume (cm <sup>3</sup> )
1	1	6	1
2	4	24	8
3	9	54	27
4	16	96	64

Length, area and volume are very important in many physical properties which change if we scale object sizes. For example, chemical reactions are affected by the amount of surface available between reactants. Heat flow is another phenomenon affected by surface area. Many devices are made considering these concepts.

Giorgia Messori | I.T.I.S. Enrico Fermi | Modena | Italy

## FRESCO AND THE HIDDEN CHEM

HOW IS A FRESCO PAINT PREPARED? WHICH SUBSTANCES DO WE NEED?

During this lab activity we are going to prepare a small fresco by firstly examining the best recipe for the mixture of lime, sand and water then describing the involved reactions, preparing a pigment as an ancient workshop painter's apprentice. Finally we are going to study the compatibility of pigments with substrates and testing their degradation.

### 1\_Make Plaster

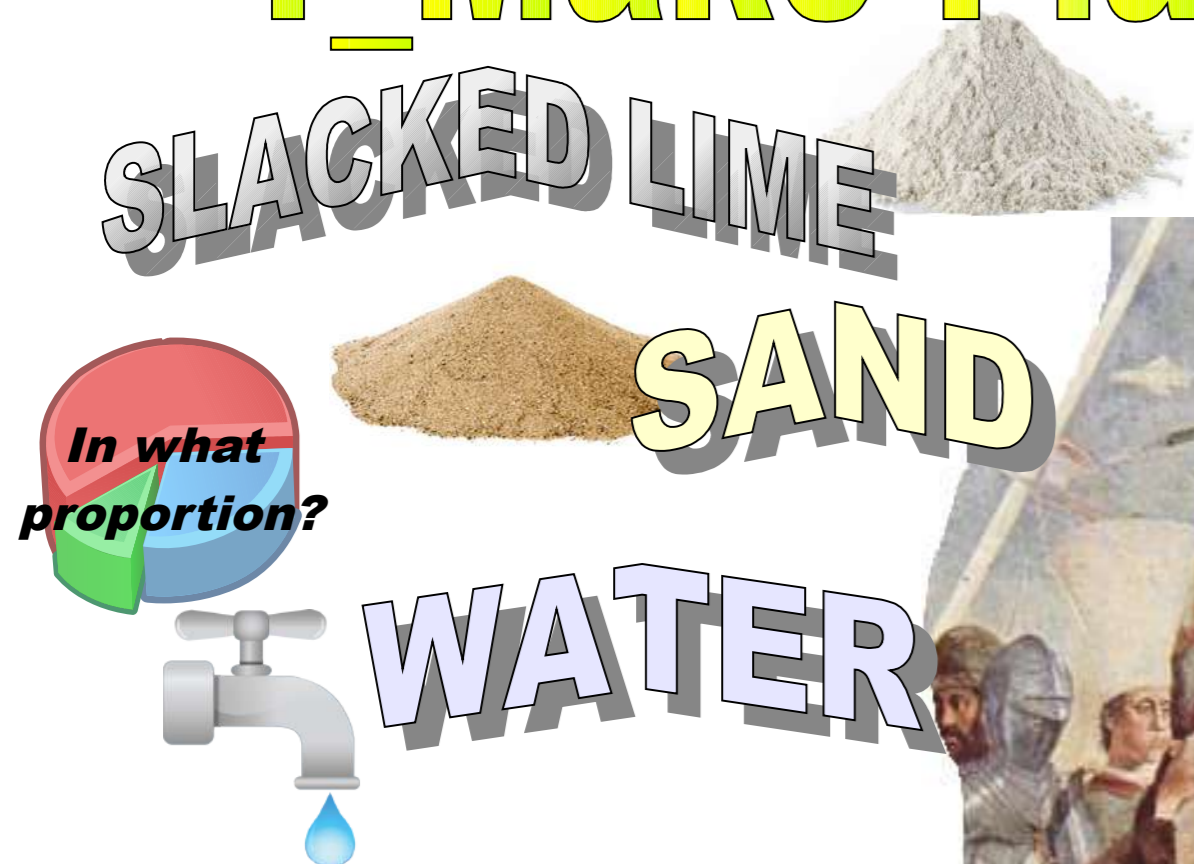

### 3\_Lay the plaster

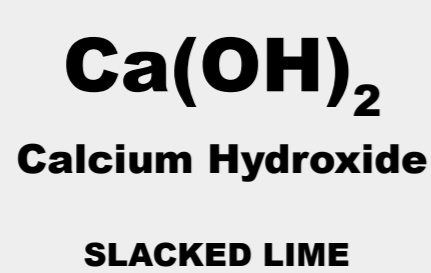

### 4\_Draw and apply

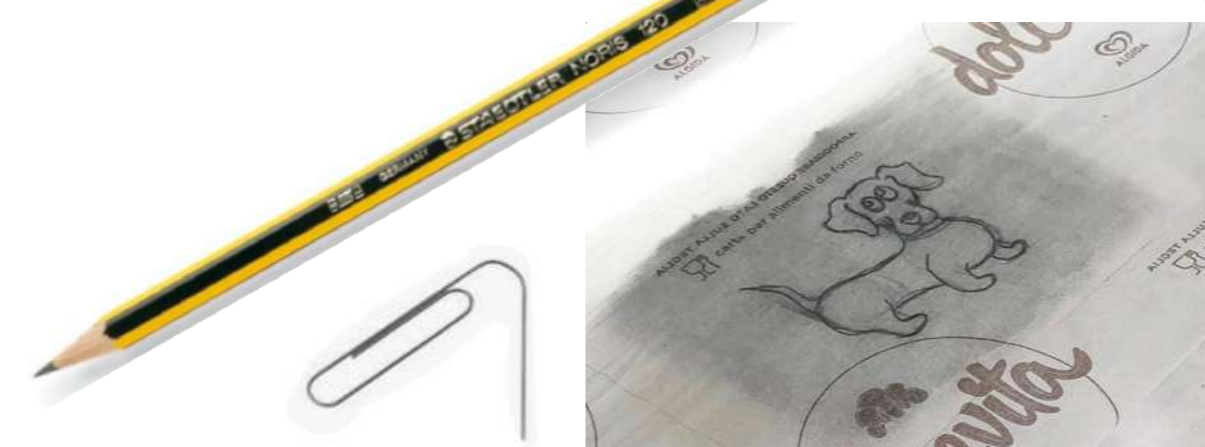

DUSTING with carbon



### 2\_Make Pigments

1 <b>H</b> Hydrogen	6 <b>C</b> Carbon	8 <b>O</b> Oxygen	20 <b>Ca</b> Calcium 40,08	26 <b>Fe</b> Iron 55,847	29 <b>Cu</b> Copper 63,546
---------------------------	-------------------------	-------------------------	-------------------------------------	-----------------------------------	-------------------------------------

PRECIPITATION  
FILTRATION  
DESSICCATION

GRINDING CLAYS  
AND  
MINERALS

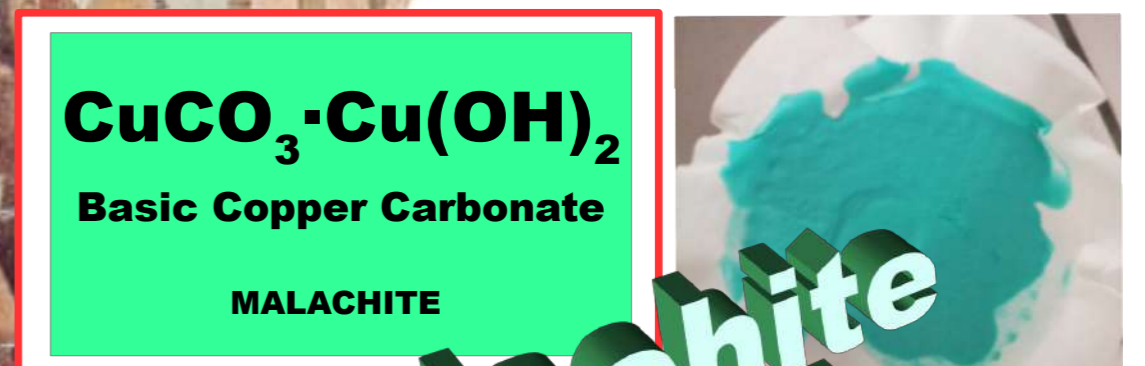

Malachite  
GREEN



AZURITE  
BLUE



Red Ochre  
BROWN

### 5\_Paint in a day!

Pigment + Water

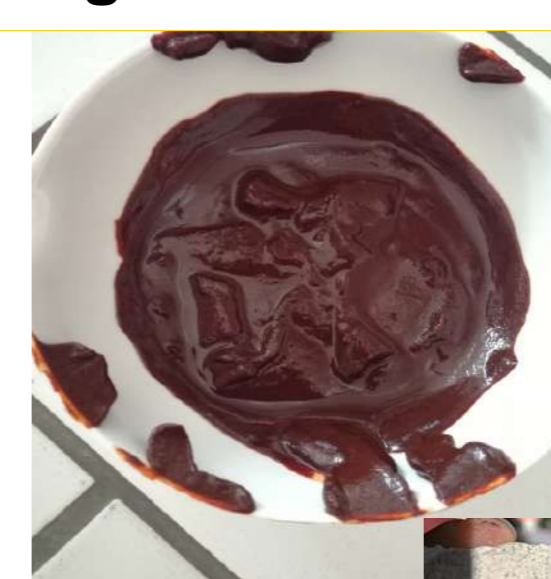

Find the elements hidden in the fresco paint

Marco Nicolini | Liceo Scientifico Statale „A.Tassoni“ | Modena | Italy

## Steam for STEM !

### Power from vapour: back to the future of Thermodynamics

We studied this old book [1842], to get some hints on steam engines and their history, to try and assemble some. We started building Newcomen's Atmospheric Steam Engine. It was designed to "raise water by fire" with the help of vacuum, or the atmosphere. It used a "mysterious" steam characteristic: its "elasticity". Raising water means getting work done by this machine. If you can shrink the steam and get vacuum space, the job is done. Then it's Atmosphere against vacuum, and the vacuum will "suck up" the water.

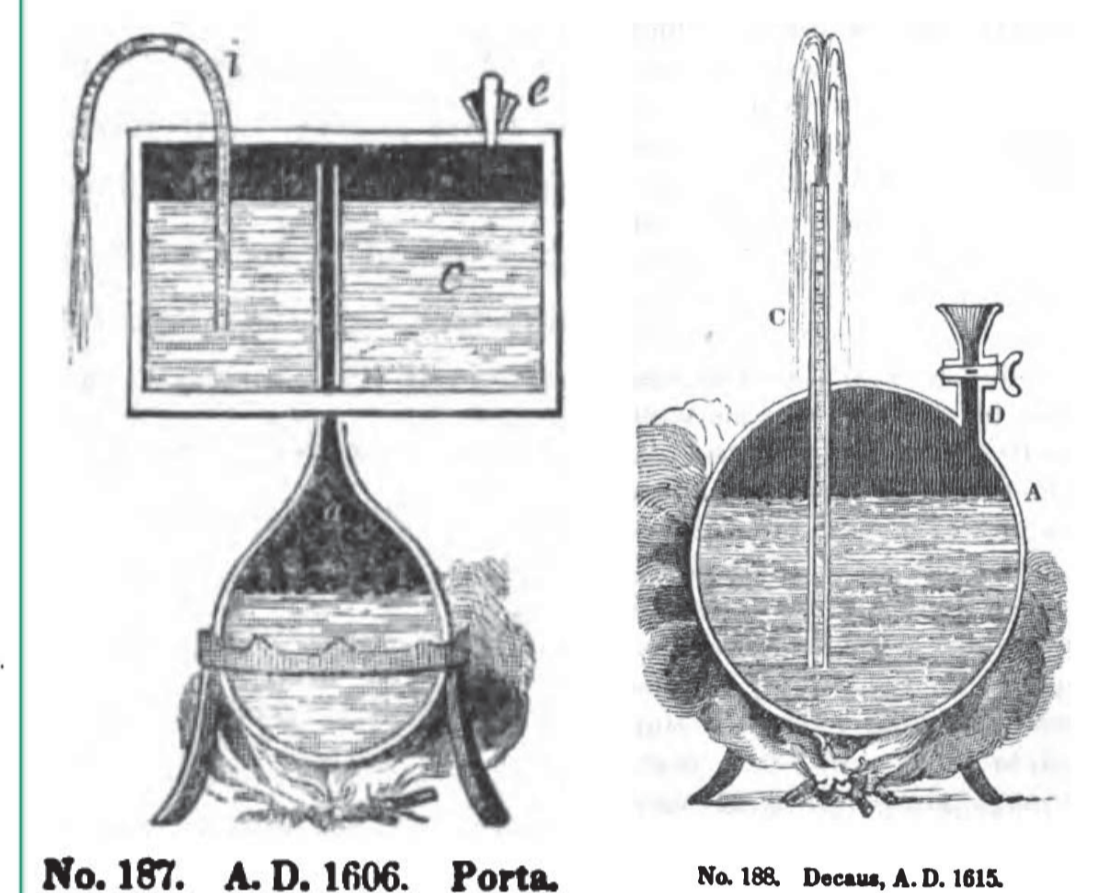
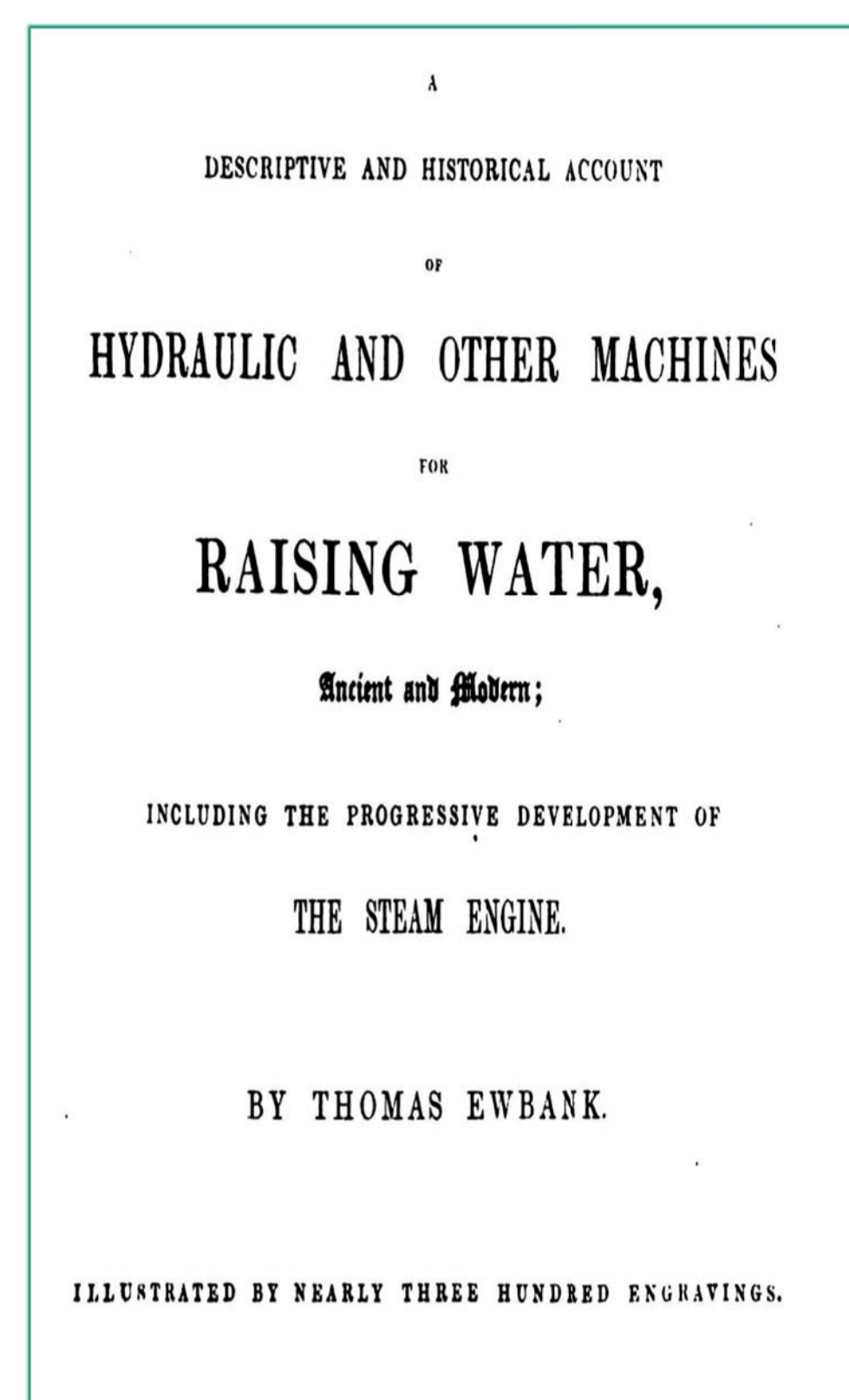

The key point of this process is heating up water to get steam and then condensing it to a lower temperature.



Phases:  
steam injection into a volume;  
steam cooled down;  
the water raises taking up the free space.

You can easily measure: the water barycentre height  $h$  (average level) and the raised water weight  $W$  to get the energy:  $E = W \cdot h$ ; the level rising time  $t$  to get the average power:  $P = E/t$ .

Thermodynamics is a difficult topic, because you get macroscopic quantities –  $p$ ,  $V$ ,  $T$  - explained ultimately with microscopic particles behaviour. This engine helps to figure out the steps needed to move energy from heat to water .

Inese Pickaine Iveta Labunska || Skrunda secondary school || Skrunda || Skrunda district || Latvia

## Live, not survive!

### Exciting and interesting experiments



An important plant

Get out A

2.



3.

Get out B

Black gold!



5. Invisible

6. It might be!



Experiments give a clear representation of the situations in nature, their impact on environment, and they promote analytical problem-solving skills using resources with minimal costs.



Rigonda Skorulskienė | Kaunas Jesuit Gymnasium | Kaunas | Lithuania

## The Challenge of Quantum Reality

**Double-slit experiment:** individual quantum objects, such as electrons or photons, are fired at a barrier with two narrow slits.

### Experiment 1:

#### Classical Particle Behaviour

Particles of sand will always behave as particles, and never as waves, because they are not quanta, electrons or photons.

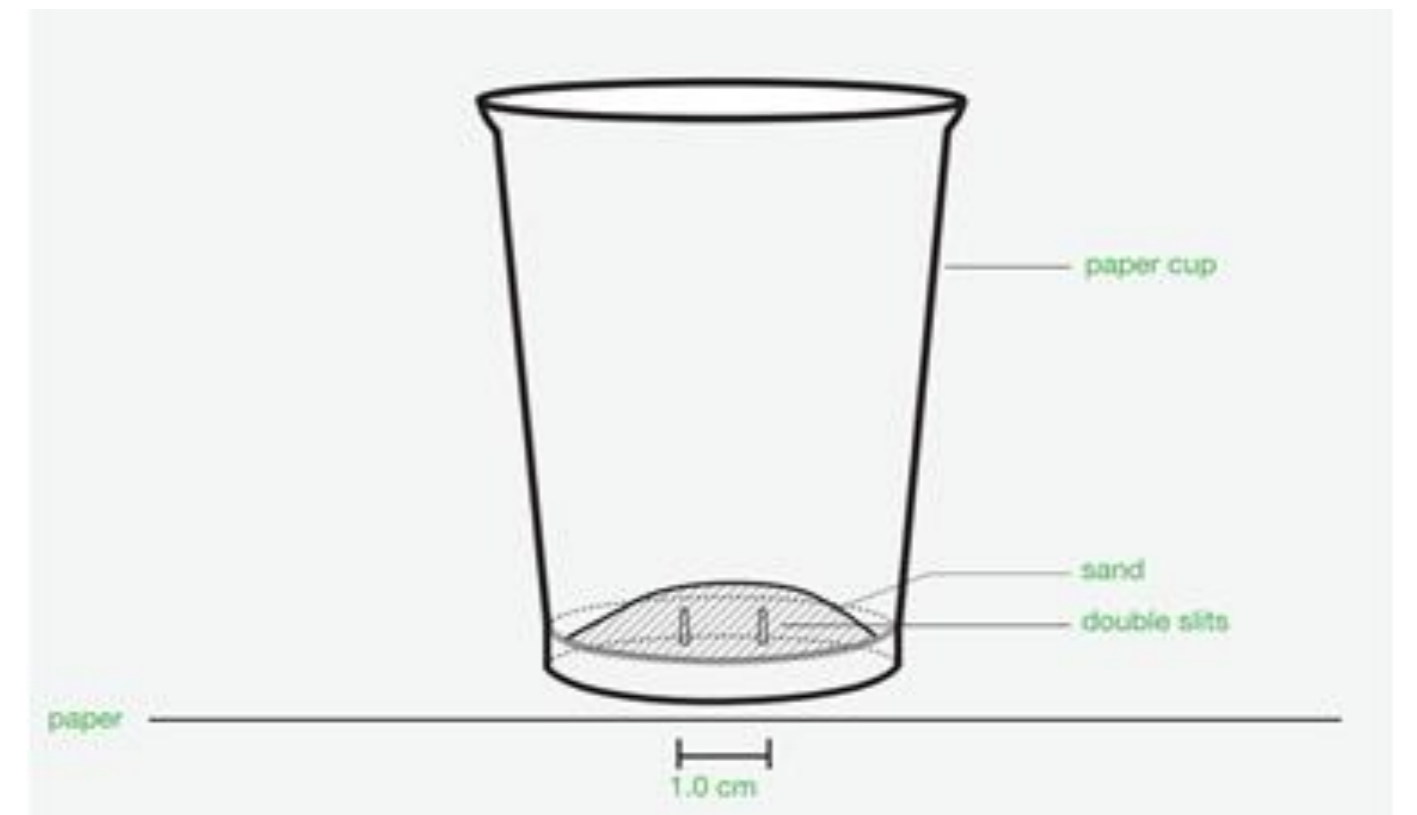
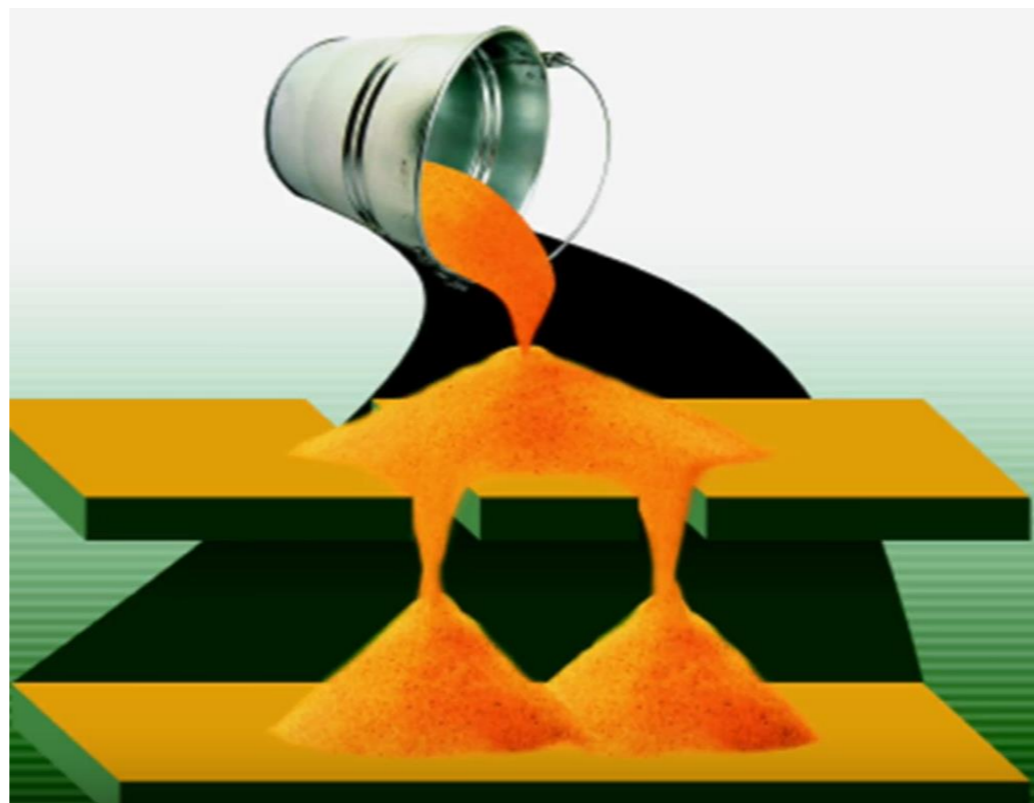

### Experiment 2:

#### Classical Wave Behaviour

When the peaks of two waves meet, their peaks add up. When meet the valleys of another identical wave, they cancel out.

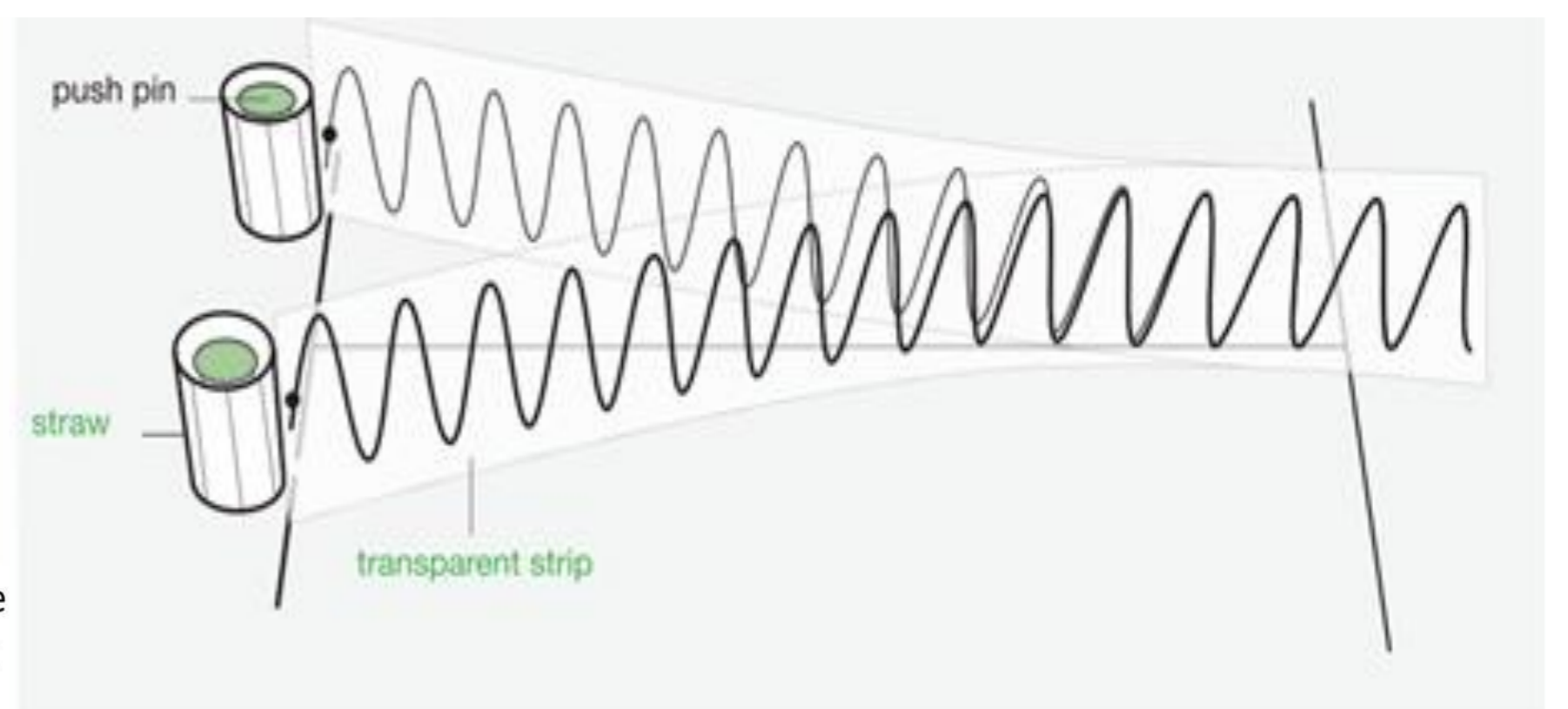
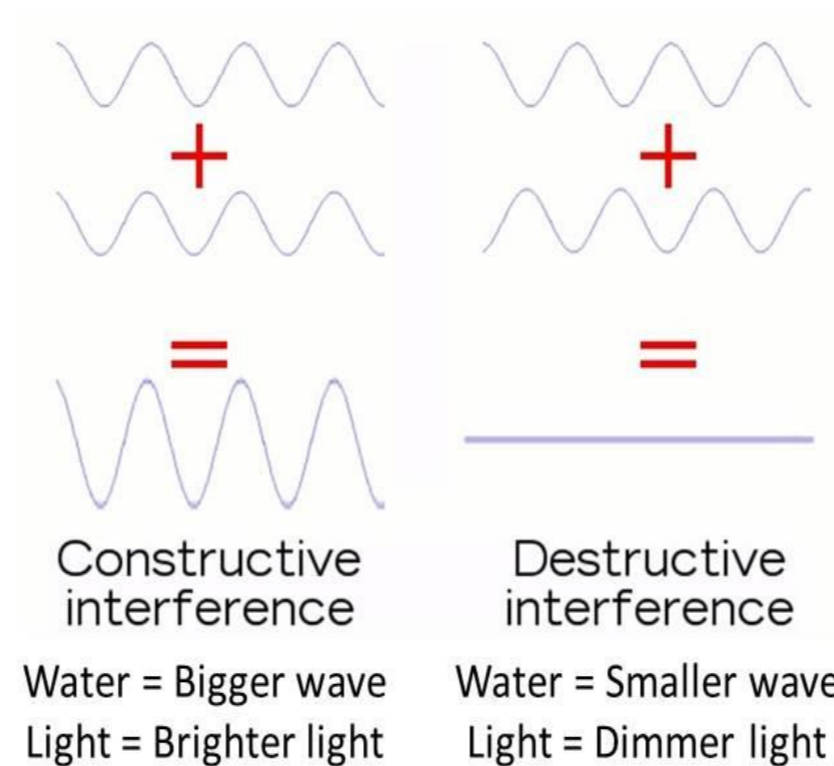

### Experiment 3:

#### Light Behaviour

Young's double slit experiment. Here pure-wavelength light sent through a pair of vertical slits is diffracted into a pattern on the screen of numerous vertical lines spread out horizontally.

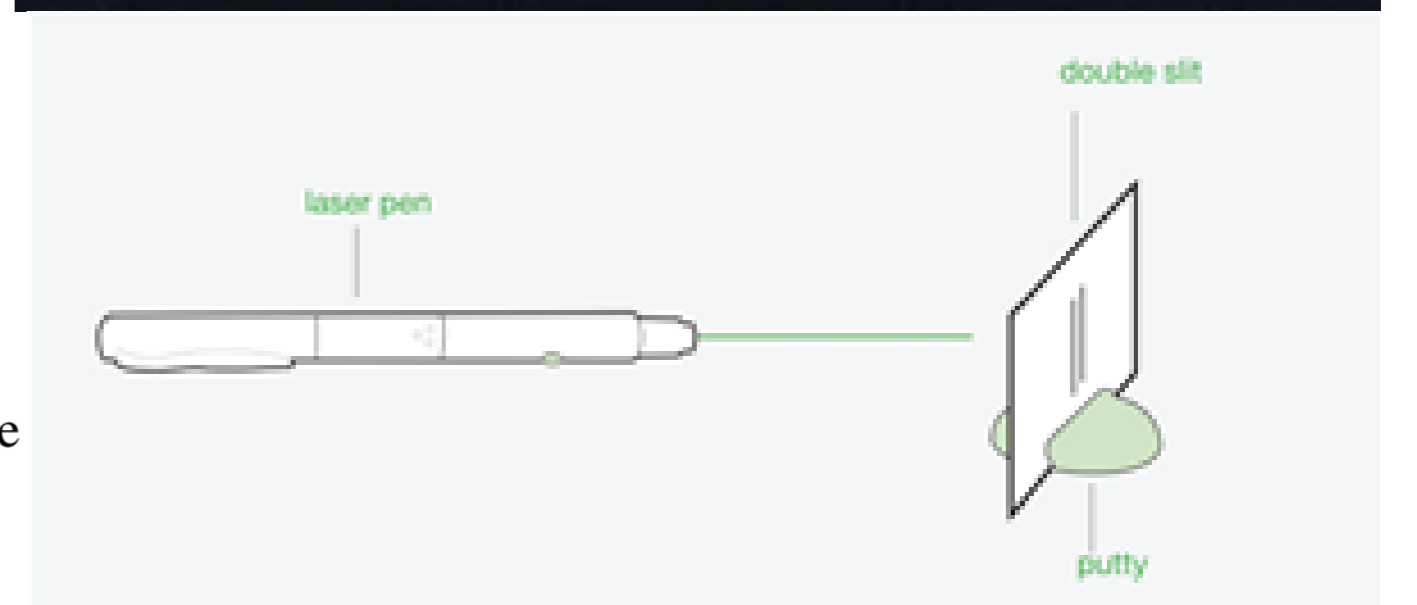
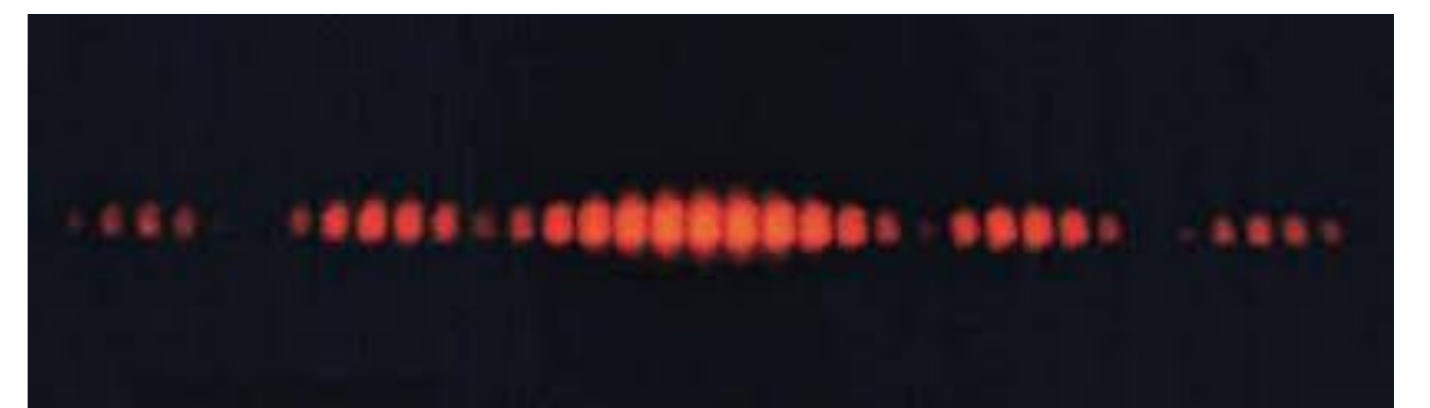
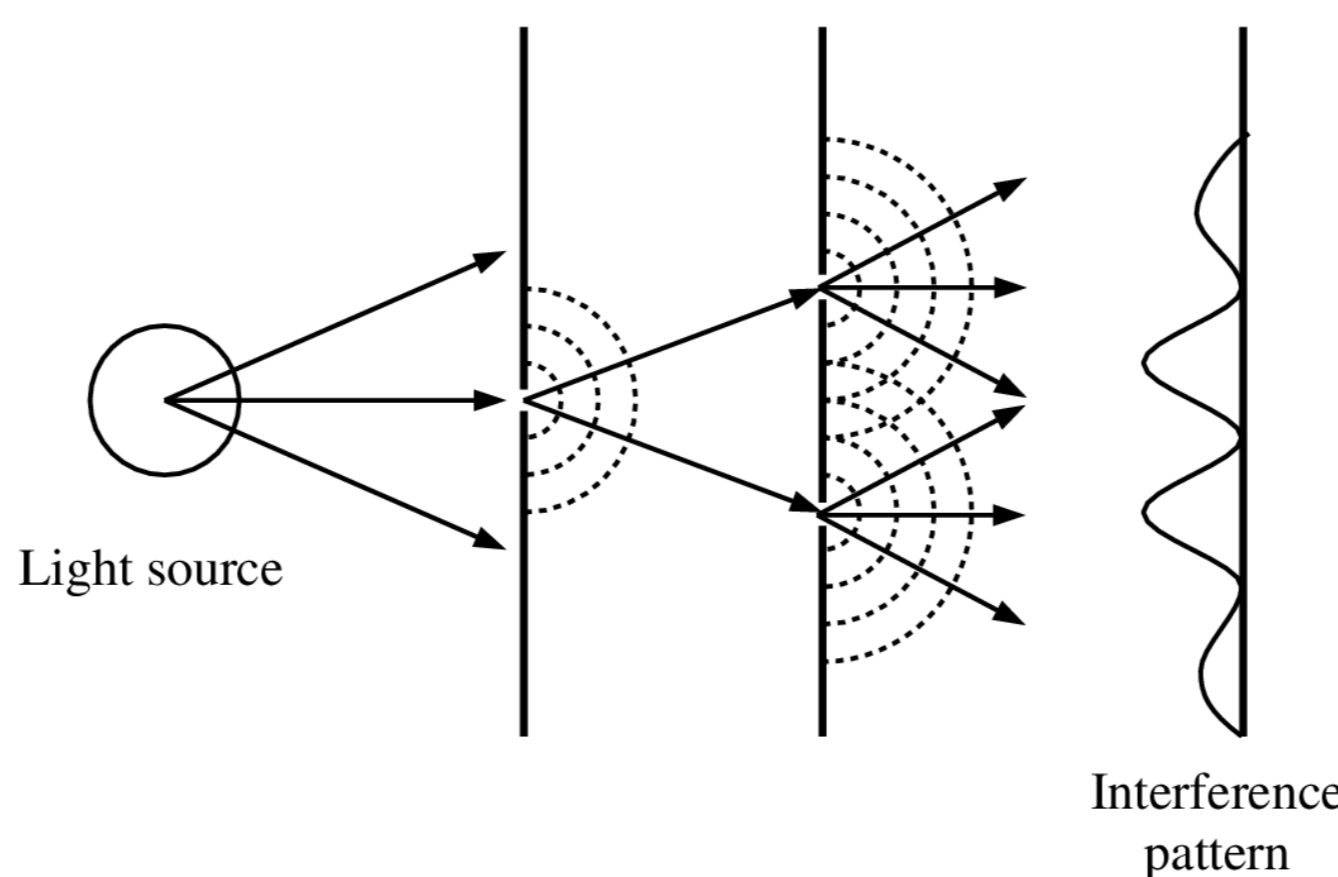

### Experiment 4:

#### Electron Behaviour

Results of a double-slit-experiment performed by Dr. Tanamura showing the build-up of an interference pattern of single electrons. Numbers of electrons are 200 (a), 6000 (b), 40000 (c), 140000 (d).

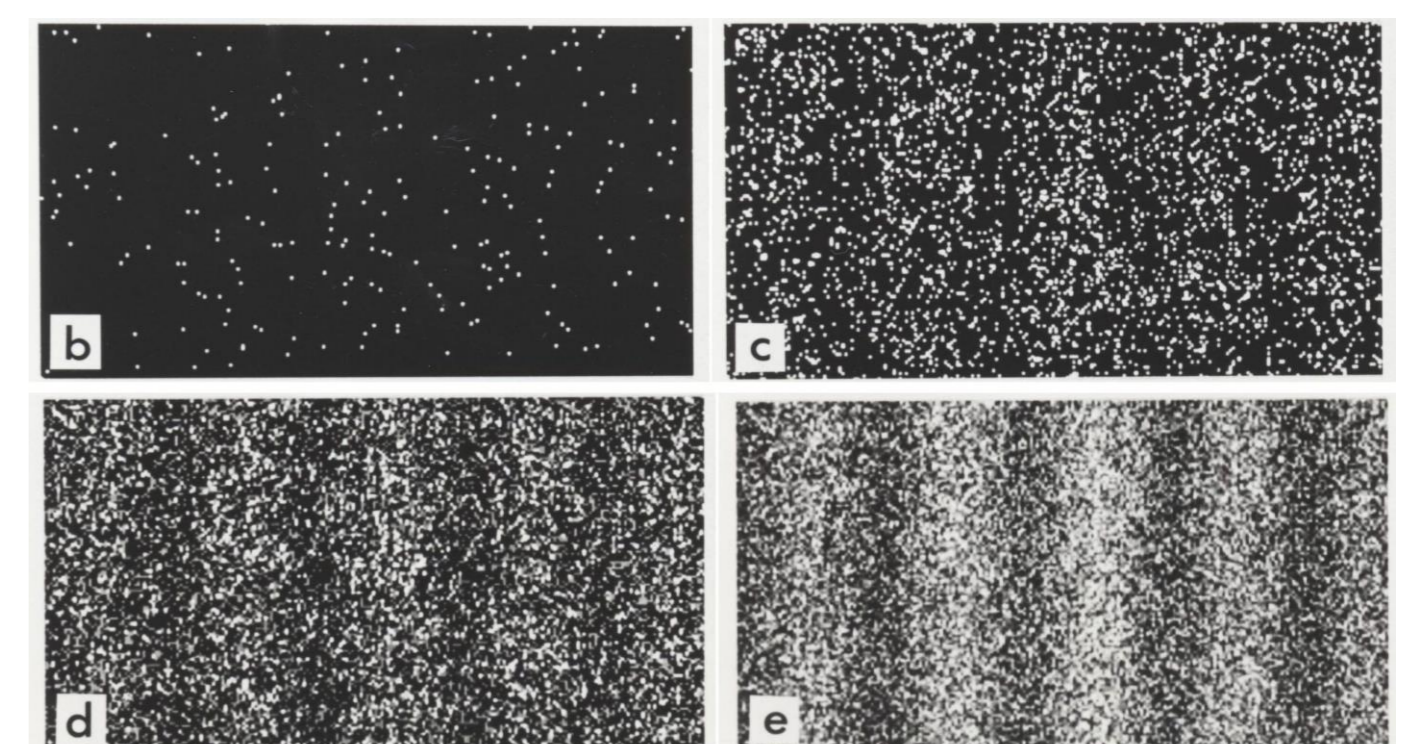
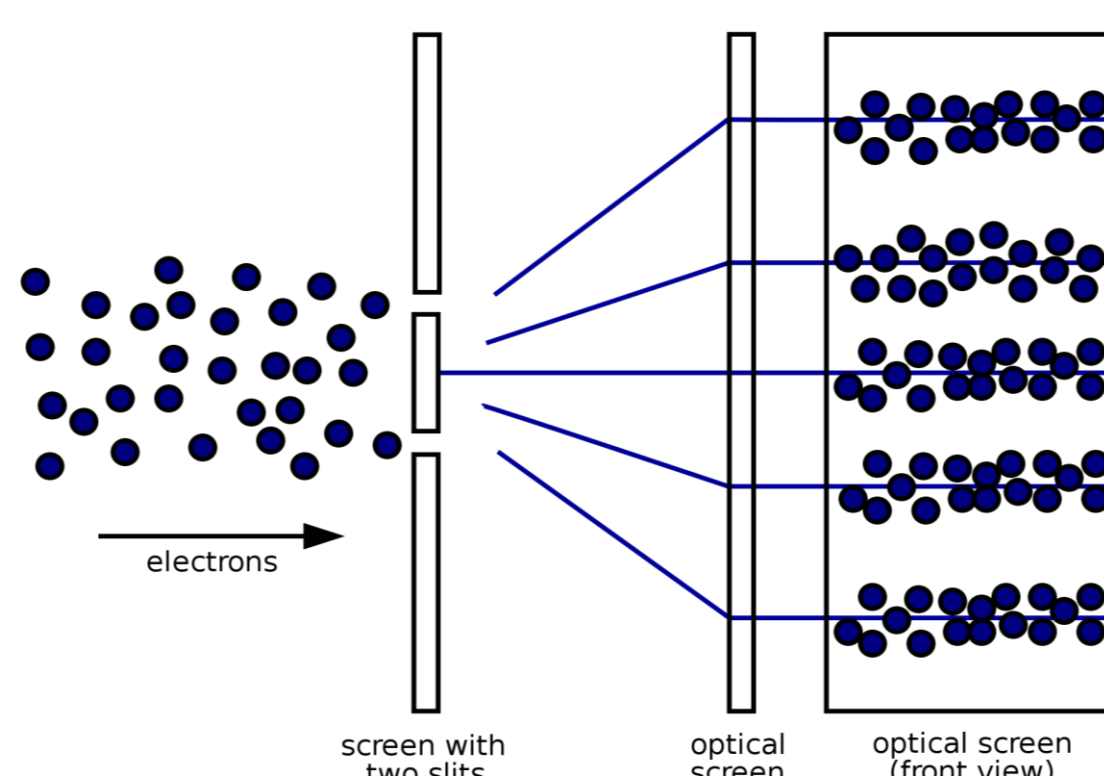

wikimedia.org/wiki/File:Double-slit\_experiment\_results\_Tanamura\_four.jpg

This result leads to one of the deep mysteries of quantum physics - **wave-particle duality** - the fact that electrons and other quantum objects behave like waves in some situations and like particles in others.

Ingeborg van der Neut | Ludgercollege | Doetinchem | The Netherlands  
(in cooperation with Caspar Geraedts, Vrije Universiteit Amsterdam)

## Embodied Simulations in biology education

### Using everyday material to simulate biological processes

#### In official language:

Embodied simulations (ESs) are teaching and learning activities in which students simulate or enact a specific process in their own interpersonal space, using tangible materials and/or bodily actions. The simulated process is usually invisible to the naked eye (e.g. because it takes place on a microscopic or macroscopic scale

#### What does it look like in the classroom?

Groups of students are moving Lego, themselves, wires or bits of paper to reenact a biological process. They discuss the process with each other. More often than not they discover that they still have questions or find out that they did not understand it as well as they thought.



Examples of embodied simulations:

Cell respiration with Lego and ATP-money

Digging for 'fossils' and making a pedigree

Countercurrent exchange with cups of coloured water

Immune system with cups, screws and bits

Circulation with yarn and sticky notes

Digestion with scissors

Conduction in a neuron with their own bodies

Transcription with DNA stamps

Embodied simulations enhance students' motivation and engagement, increase students' understanding, reveal misconceptions (for both teachers and students), and help students to remember the simulated process.

Wiesława Idziak, I High School of Tadeusz Kościuszko, Jarocin, Poland  
Adam Buczek, Poznan University of Technology, Poznan, Poland

## Experiments with gelatin and sugar

The project shows the usage of simple, easily accessible materials of everyday use to develop students ability to do research. It is possible to cut transparent forms of different shapes from solution of gelatin after it settles (fig. 1, 2). Younger students can observe simple optic experiments with the help of gelatin shapes (fig. 3, 4). Older students are able to design their own optical sets and to conclude how to use them in technics and the medicine of eye. Testing lens aberrations and the track of rays in their optical sets is a good example (fig. 5, 6). In the programme for more advanced students it is possible to find quantitative parameters: the refractive index and the speed of light in gelatin.

Another material letting us show interesting experiments is sugar. A good set for such an experiment is shown in fig. 7. A green beam from laser (7a) goes from the top through saturated solution of sugar in a transparent container (7b). The surface of this solution is sprinkled with clean water. Any movement is shown on a screen placed underneath (7c). What is seen are streaks resulting from differences in refraction in both liquids. One can observe the laws governing fluid mechanics. A good example are picturesque whirls created by moving objects in solution (fig. 8).

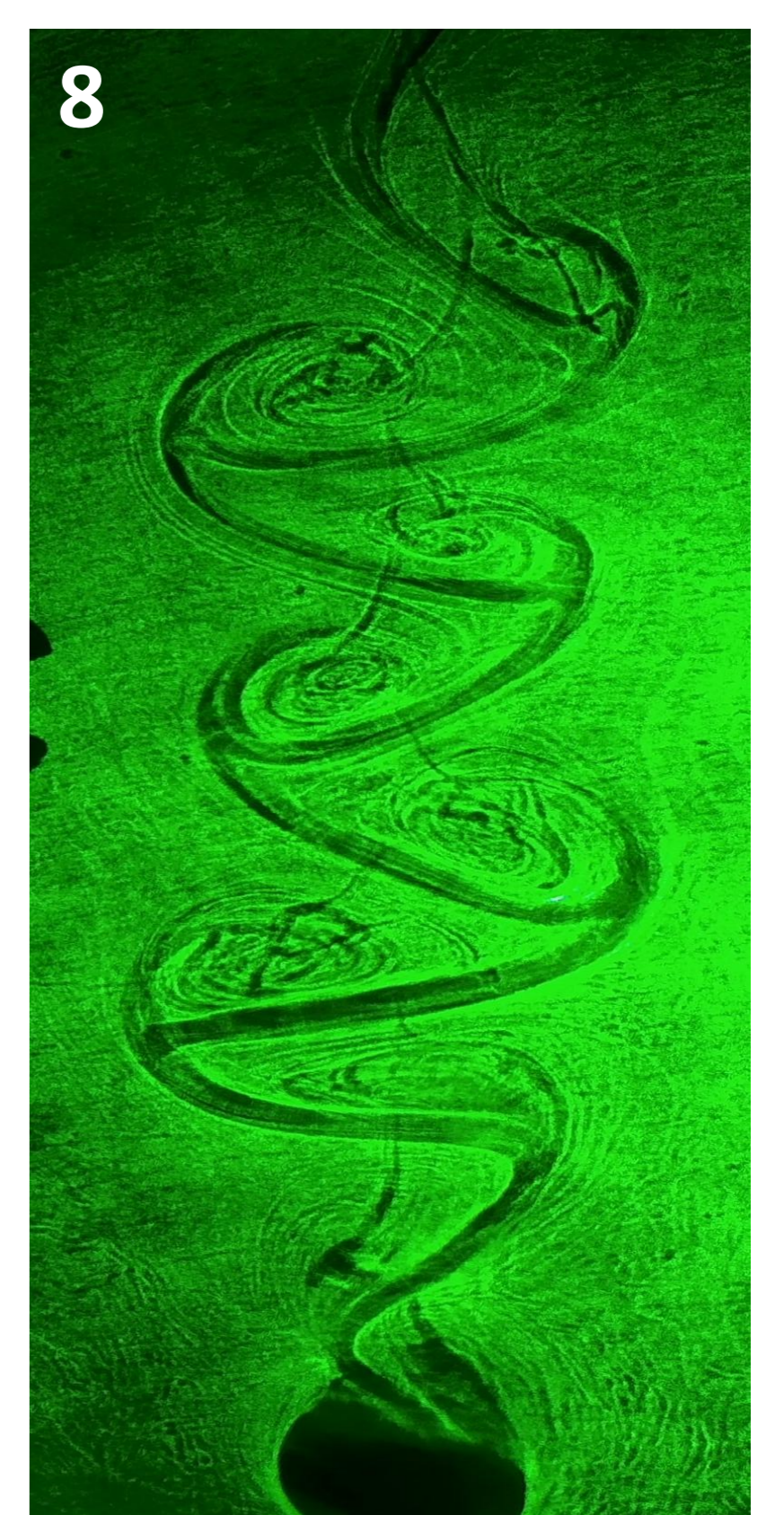
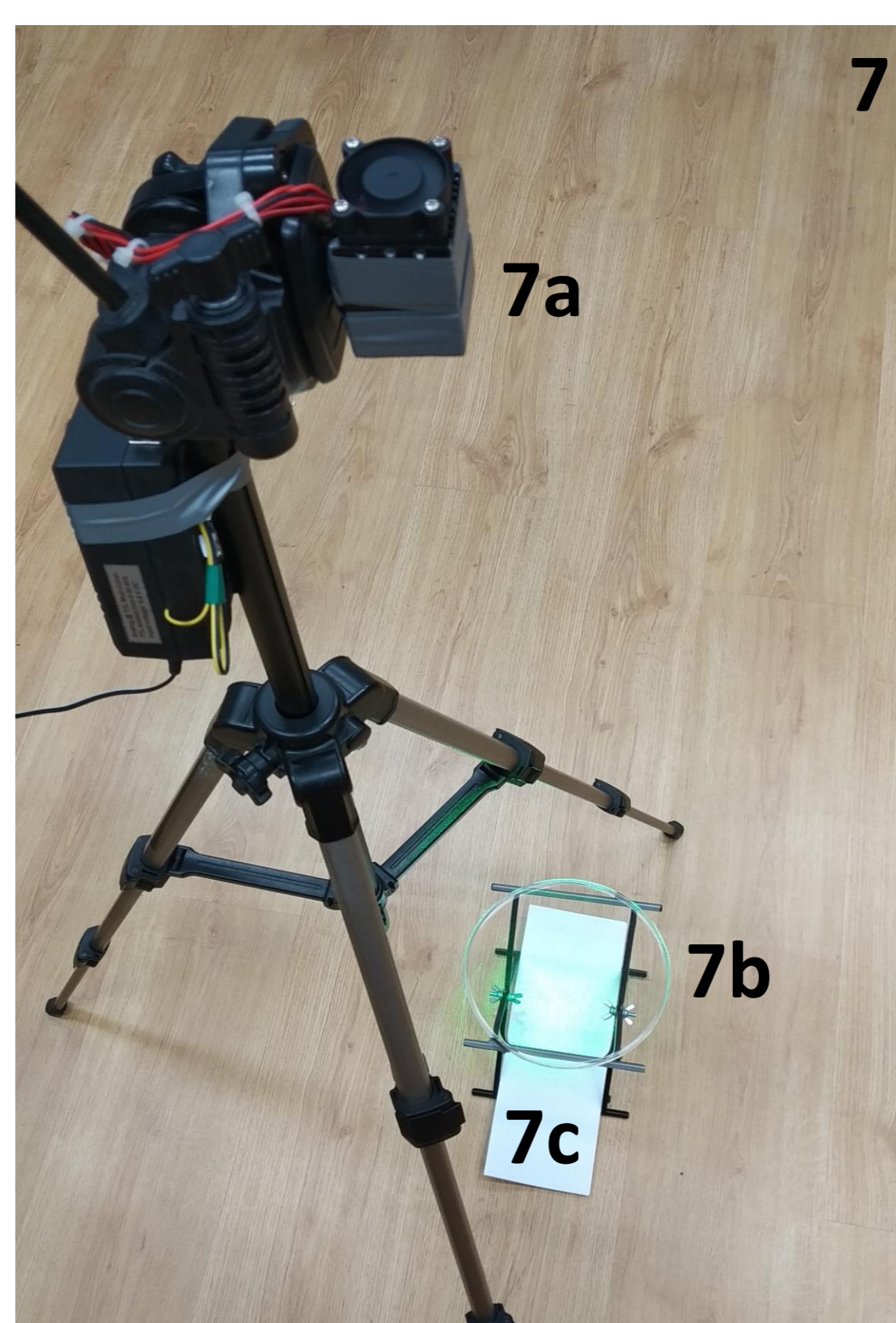
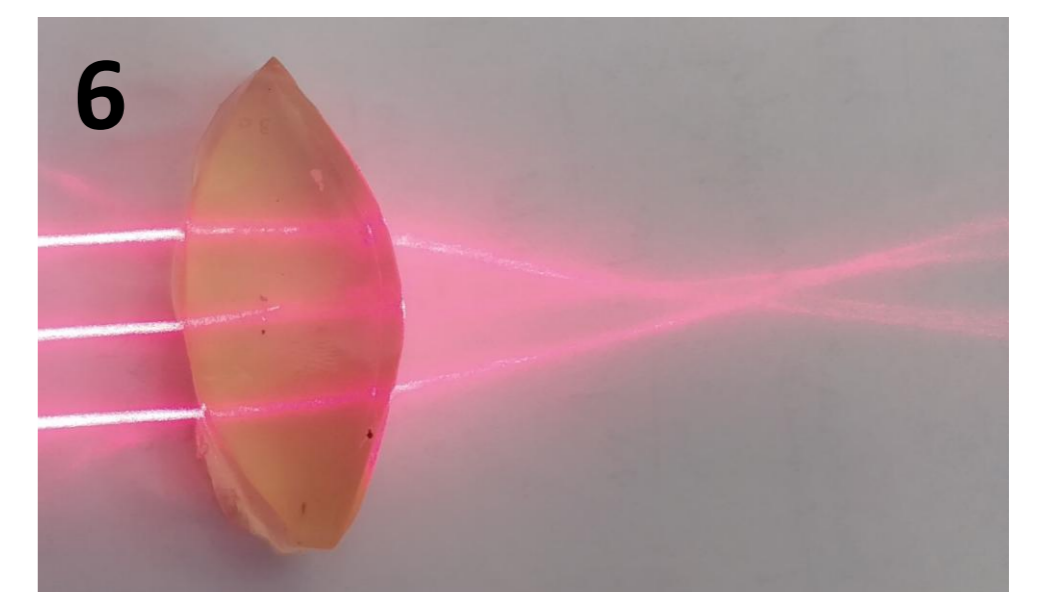
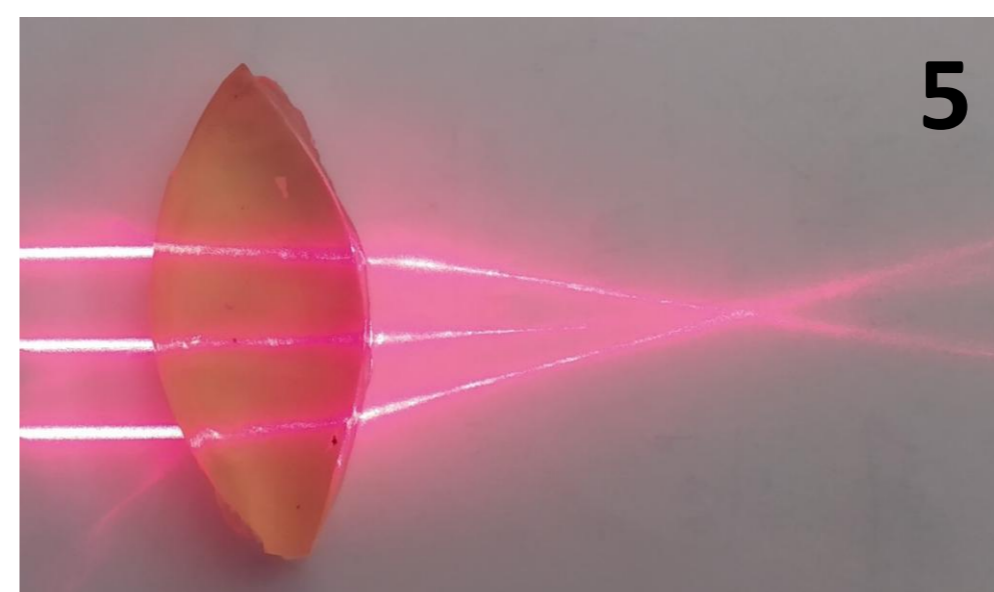
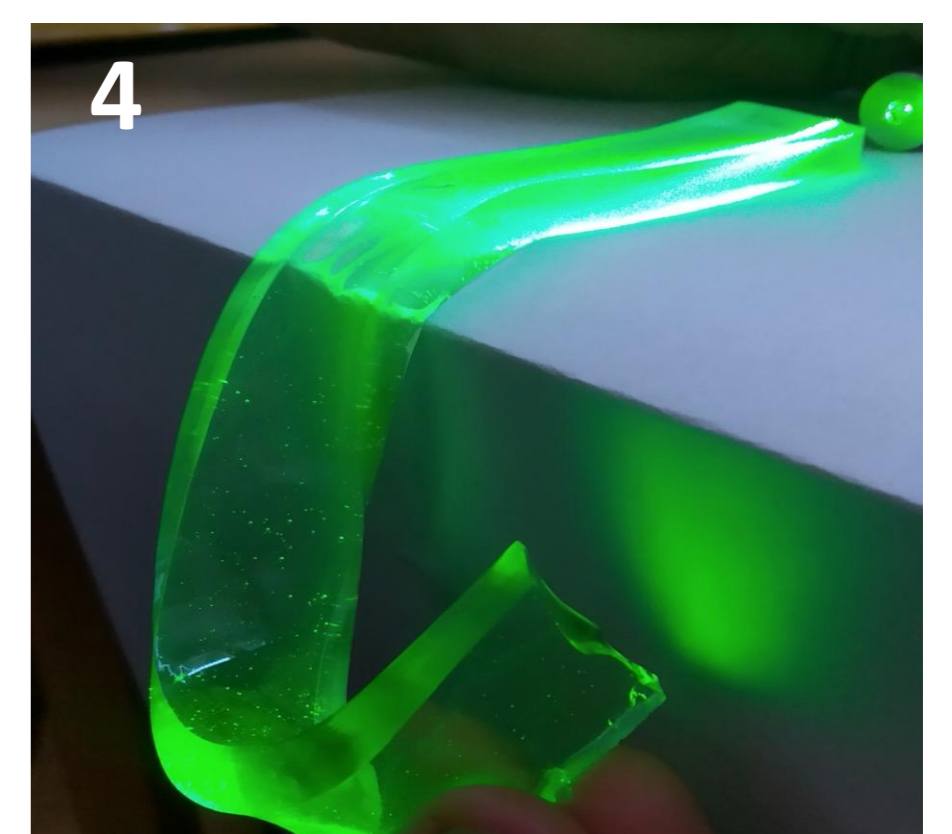

**Conclusion:** Commonly used substances give us a chance to make interesting experiments building scientific abilities of students of all ages.

M. Sc. Malgorzata Masłowska | III High School of Nicolaus Copernicus | Kalisz | Poland

## Curie engines

The **Curie engine** is a thermal-magnetic engine based on the loss of ferromagnetic properties of the material at Curie temperature.

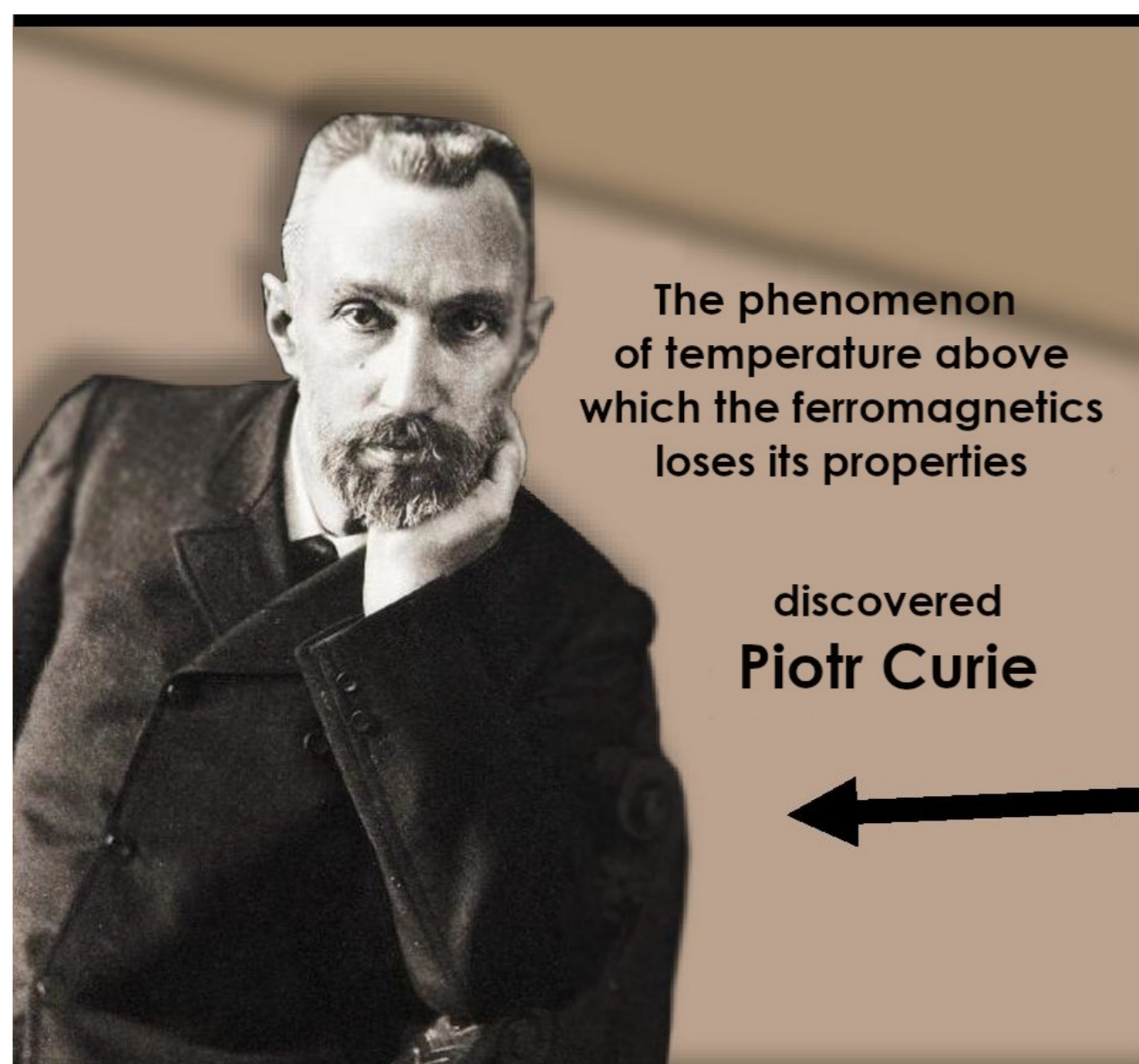

**Curie temperature:** the temperature above which the ferromagnetics rapidly loses its magnetic properties and becomes a paramagnetic.

In the experiment, we used:

- nickel, a metal with ferromagnetic properties. We used this substance because of its relatively low Curie temperature and market availability.
- a few small neodymium magnets.
- a candle as a source of heat.
- copper wires, because they do not show ferromagnetic properties.

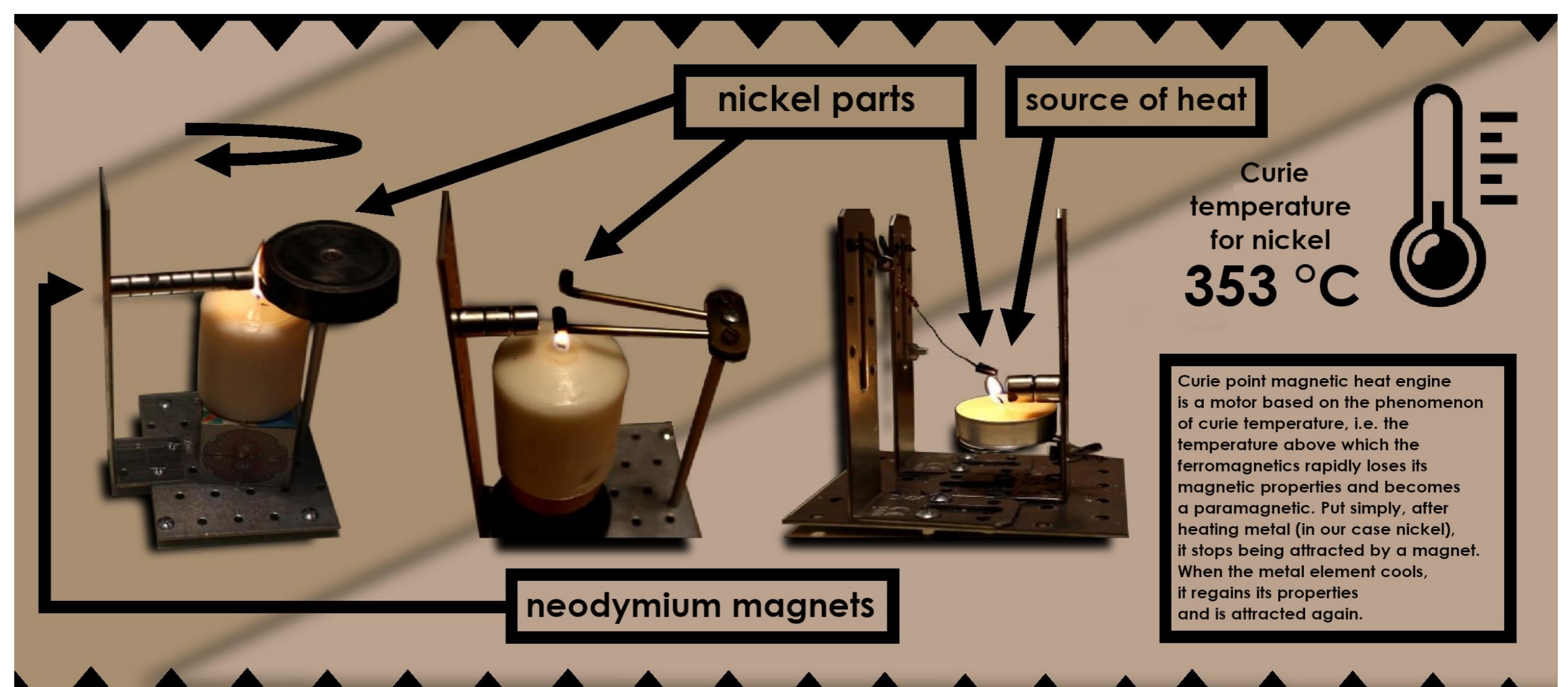
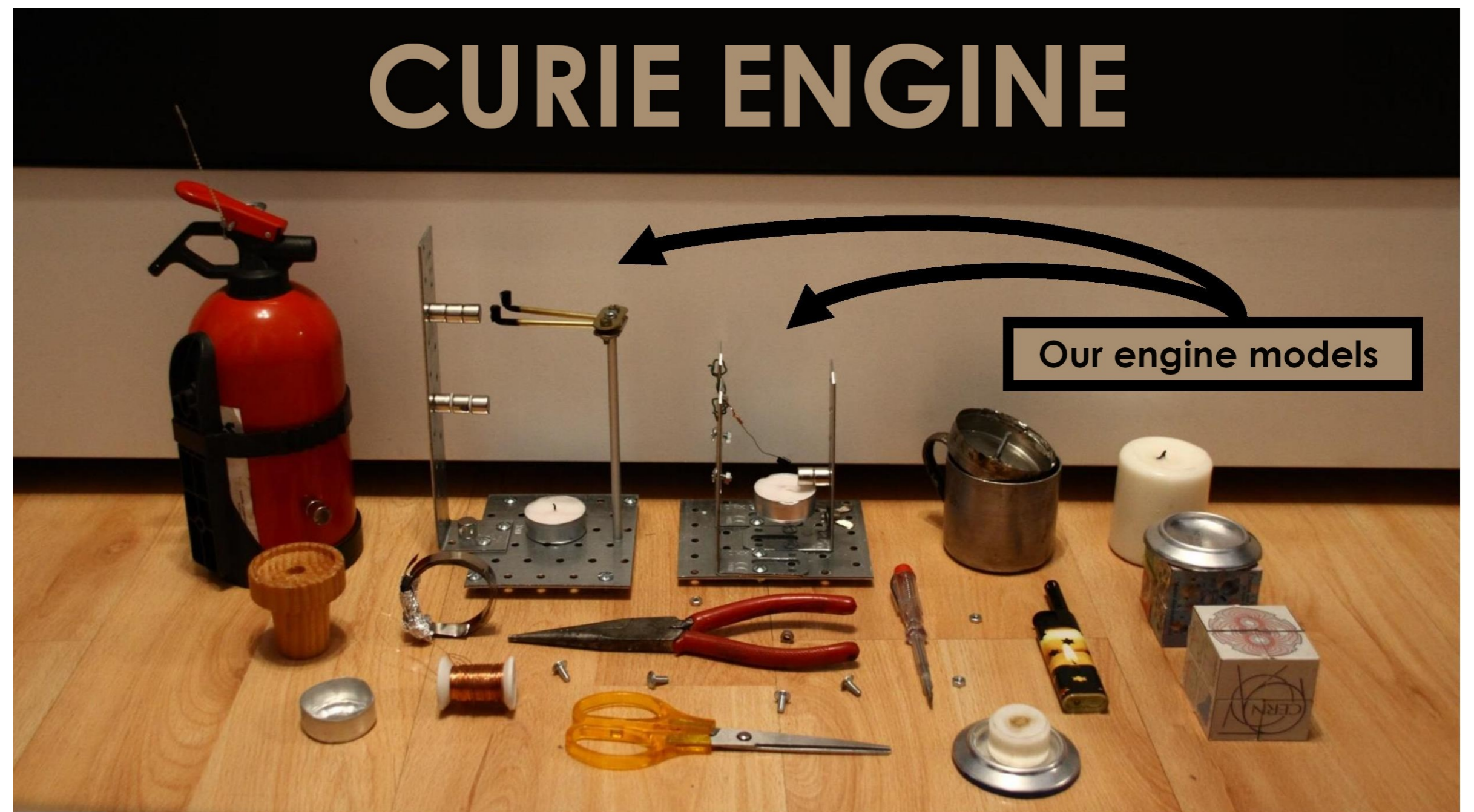

M. Sc. Malgorzata Maslowska | III High School of Nicolaus Copernicus | Kalisz | Poland

## See the sound

### Dominika, Krzysztof and an old CRT TV set

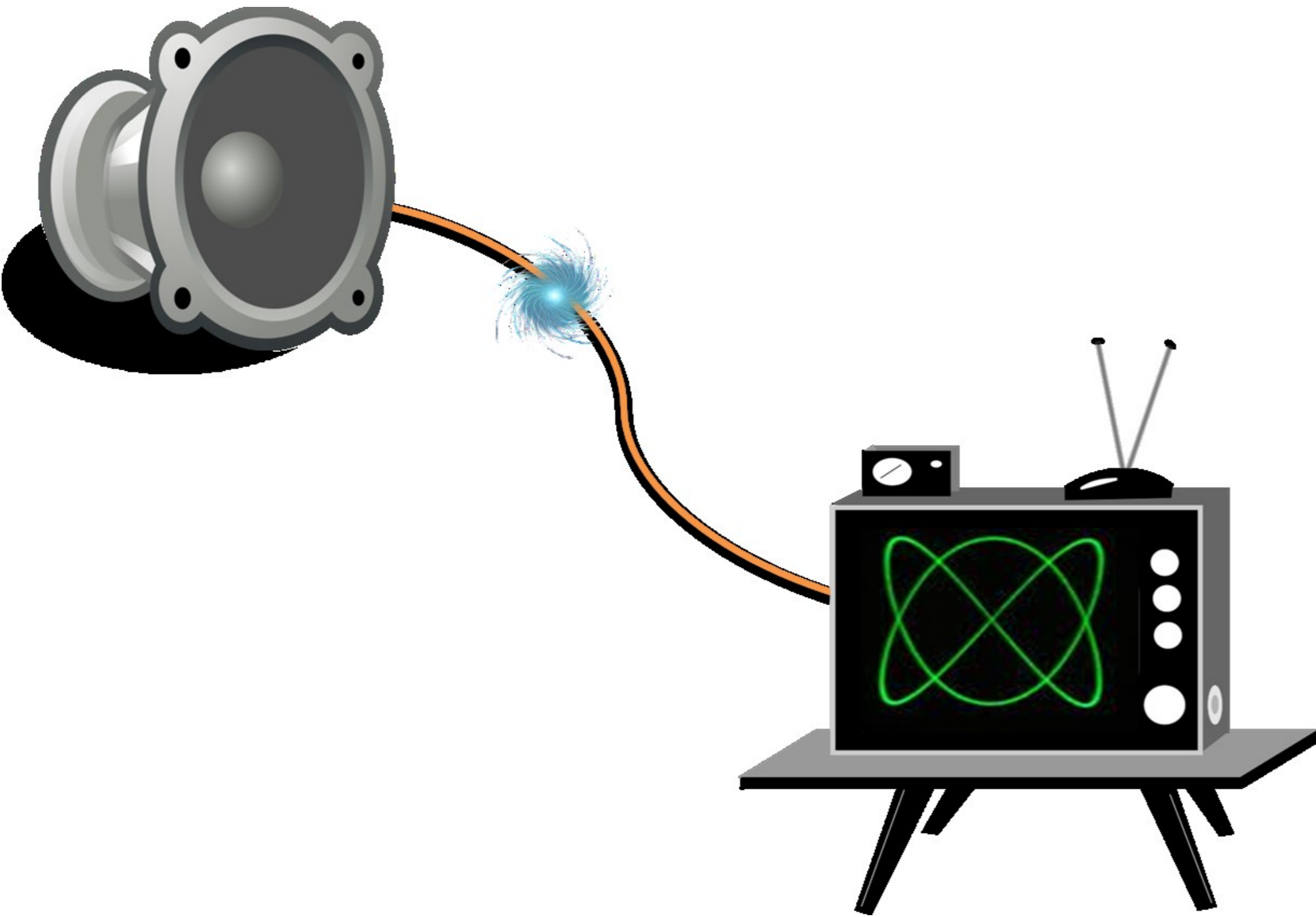

We present to you an original composition, arranged and produced by Krzysztof, with a text written by Dominika, which you will be able to literally see on the screen of an old TV set.

Why did we just choose a CRT TV set? Due to the similarity of its operation to the oscilloscope. No plasma screen, LCD screen or any other one in our homes will work this way.

The phenomenon whose result we observe on the screen consists in shooting electrons in certain parts of the screen, which is controlled by the signal voltage, in our case an audio signal, that is supplied to the deflection coils in the kinescope.

One of these coils allows you to deflect the electron beam horizontally and the other vertically, which gives us the opportunity to reach virtually every point on the TV screen.

In this way, parabolic curves are created, called Lissajou curves, which are a combination of two harmonic waves, one in a horizontal plane and one in a vertical position.

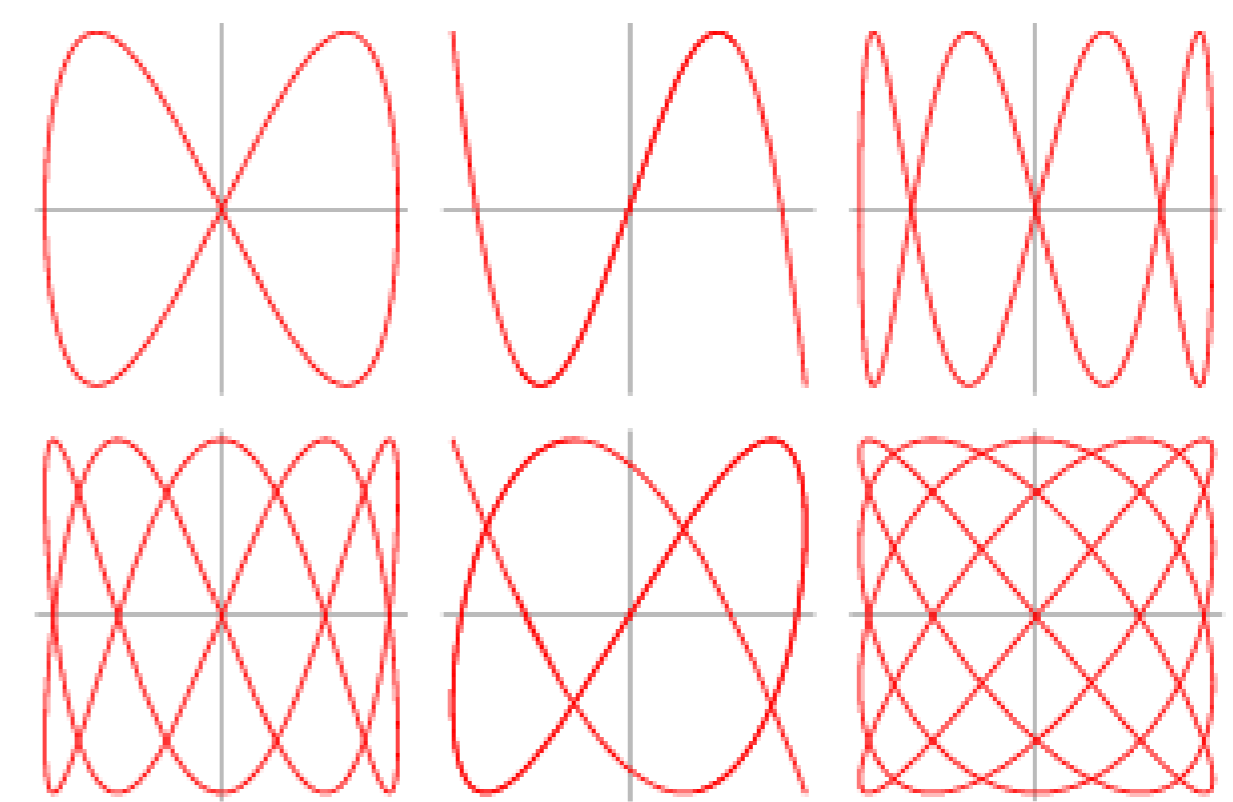
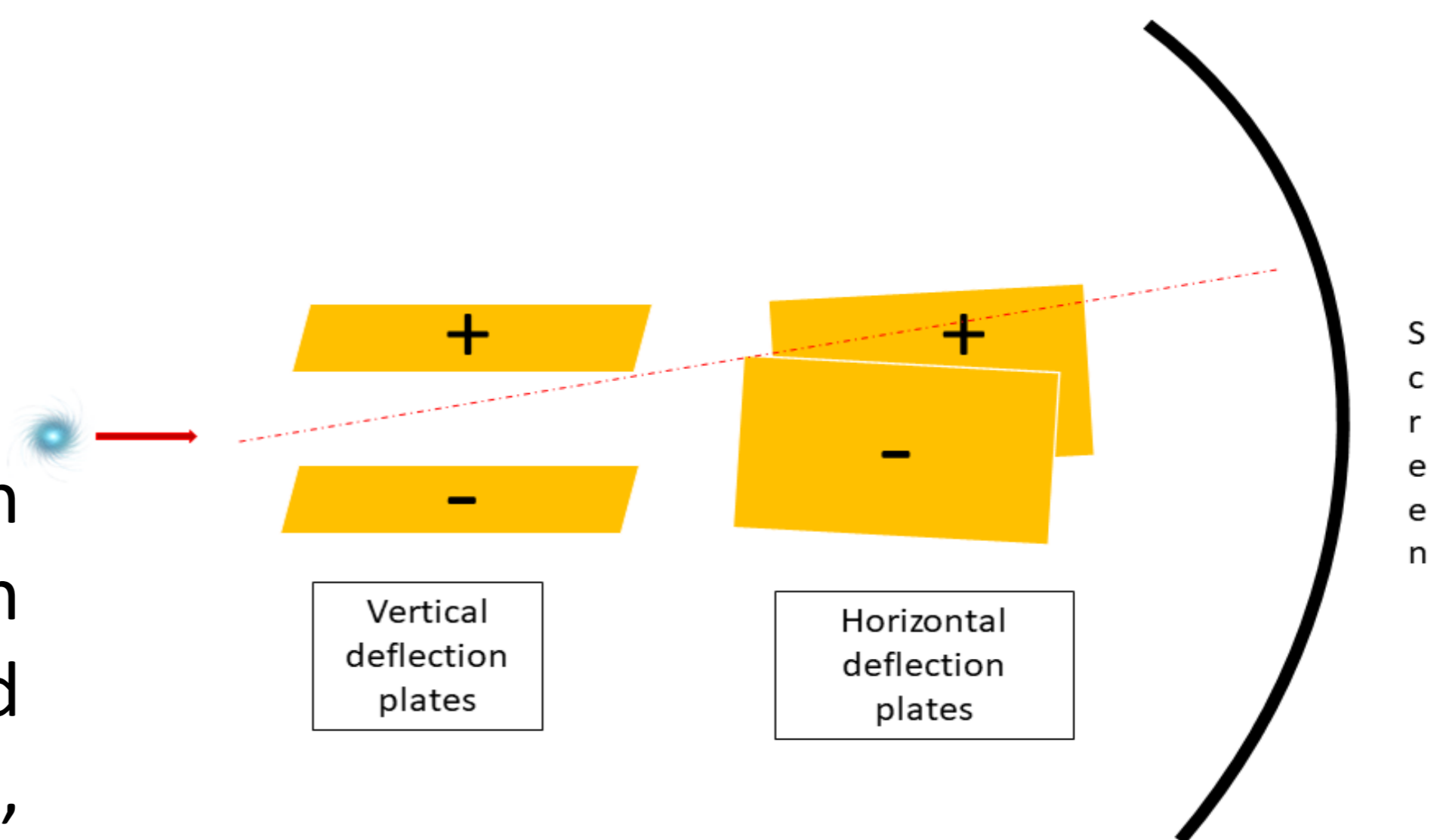

[http://mathworld.wolfram.com/images/eps-gif/LissajousCurves\\_851.gif](http://mathworld.wolfram.com/images/eps-gif/LissajousCurves_851.gif)

This inspired us to create the song and video clip "In the glass screen,,  
You can watch and listen to it on YouTube: <https://youtu.be/8AnClyFYKg4>  
Enjoy and learn physics with us! Have a nice reception!



Zofia Ruszkowska, Konstancja Nowakowska | Primary School | Złoty Stok | Poland

## „TOP MODEL”

The "Top Model" project is a show that takes viewers into the fashion world. Music, lights and stage are the pageantry for models presented by individual participants. The models present phenomena and physical, chemical and biological processes. The audience observes the structure, the principle of operation and the use of individual models. Waste sorting and recycling have a significant impact on the retrieval of raw materials, energy saving and the environment. That is why the students use the waste material for designing their models. The "Top Model" project tries to answer the question: which model was, is and perhaps will be the most important for humanity?



Conclusion: " Logic will lead you from point A to point B.  
Imagination will lead you everywhere".

(Albert Einstein)

Luis Afonso | Escola Secundária José Gomes Ferreira | Lisbon | Portugal

## Old sensors recovery

### Gravity acceleration measurement

Most of the sensors in schools are inoperative due to the lack of interfaces and / or calculators / pc. The project main goal is recycle old sensors. As an example, we use photogates and measure gravity acceleration and other physical quantities. The photogates are attached to an arduino board. The card has a shield that send data to a mobile phone via bluetooth. This low cost electronic system can be used with other old sensors to promote recycling. This work is useful to students as well as to teachers to enable the realization of many projects.

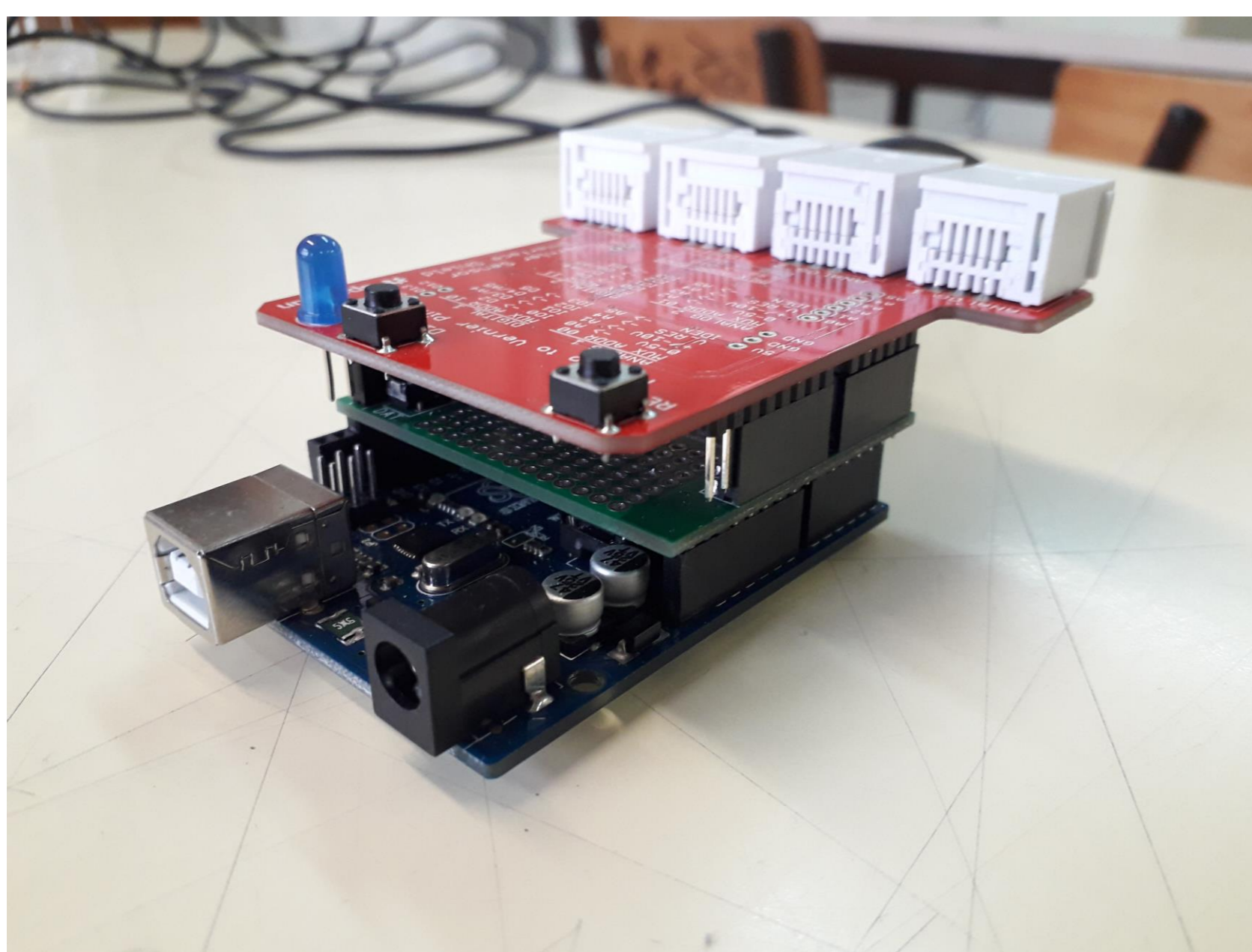
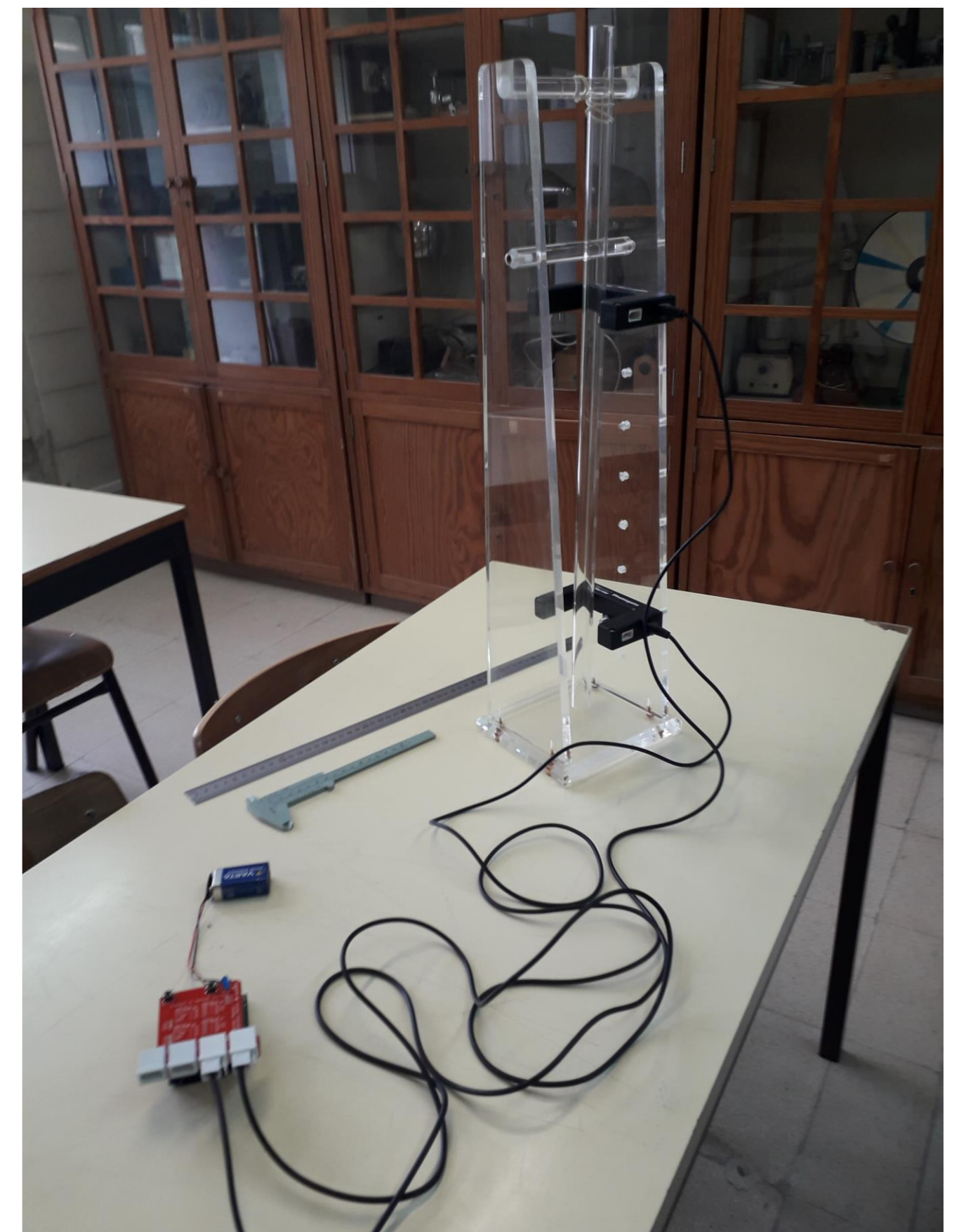

The use of sensors requires an interface and a data reading system. In some situations schools only have the sensors in working order. To reuse these sensors it is necessary to establish the path between the sensor and the acquired data observer. To do this is necessary: a connection cable from the sensor to the interface; an interface (arduino uno, shield and bluetooth emitter); an arduino code (C ++ programming); a bluetooth receiver (in our case a mobile phone with an application that simulates a bluetooth serial data terminal).



All the project and tips for its application can be consulted at <https://sites.google.com/a/fiscadascoisas.pt/inicio/projetos-internos/recuperacao-de-sensores-antigos/duas-photogates>.

The old sensor device was successfully used by students with photogates as well as position and temperature sensors with excellent precision of results.

Paulo Gil | Escola Básica e Secundária de Pinheiro | Termas de S.Vicente | Portugal

## History of Maths in classroom: an educational challenge

This project intends to show the role of the history of mathematics in the classroom context, aiming the development of communication and mathematical argumentation, as well as the development of problem solving strategies. The integration of the history of mathematics arises through the proposal of tasks based on historical sources, involving different thematic areas, such as geometry, algebra and probabilities.

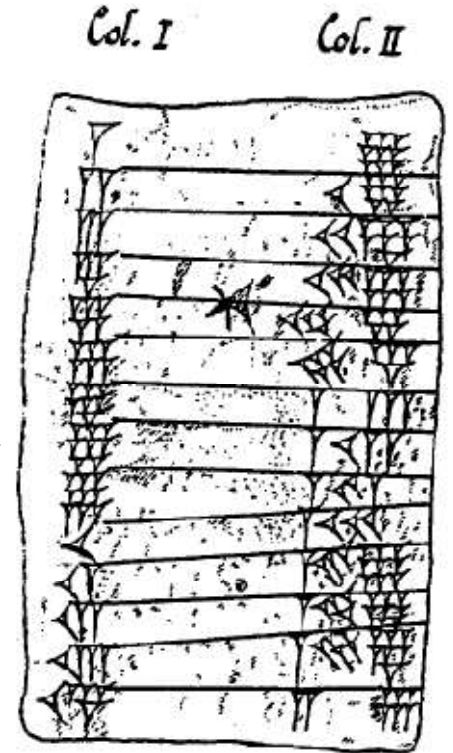
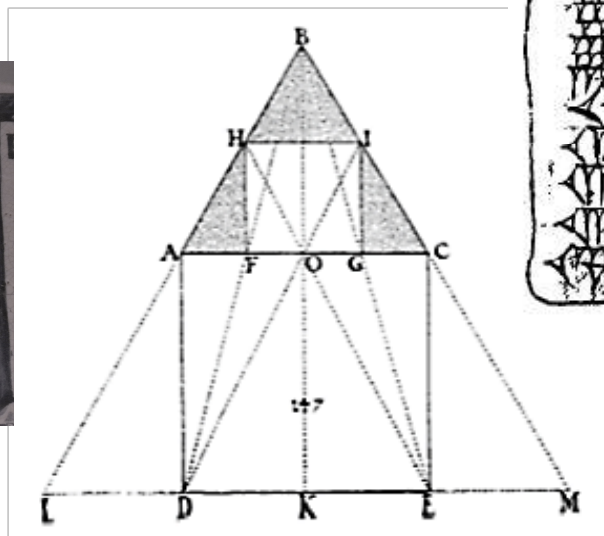
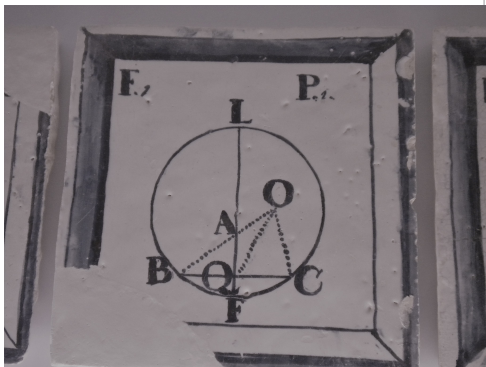

$$x^2 + q = px$$

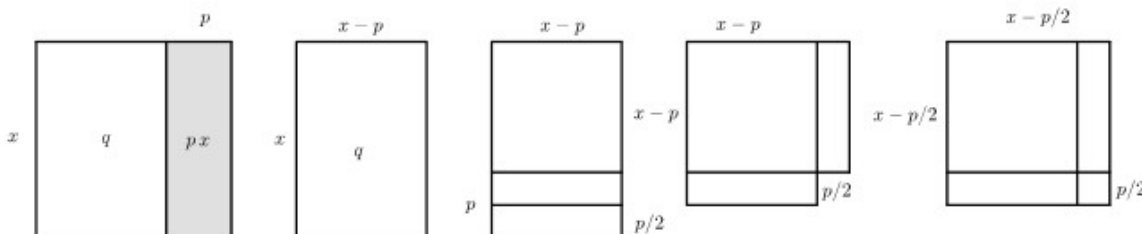

$$x - \frac{p}{2} = \sqrt{q + \left(\frac{p}{2}\right)^2}$$

The analysis of historical questions, problems or answers, from primary sources or reconstructed texts, are ways to provide students with alternative methods of resolution, leading to the development of mathematical thinking.



César Marques | csrmrqs@gmail.com | Almada | Portugal

## The Periodic Table of the Smartphone

Today all students have a Smartphone but ... what substances and mixtures does it have in its constitution? This is the starting point of the study of the matter organization. Using printed cards, with different geometric images, students arrange ways to group these cards together. After knowing what substances and mixtures are, students organize the supplied elements (Bohr models of atoms) based on their characteristics, making predictions of elements, as Mendeleev did, thus understanding the importance of the Periodic Table and the information that it gives us.

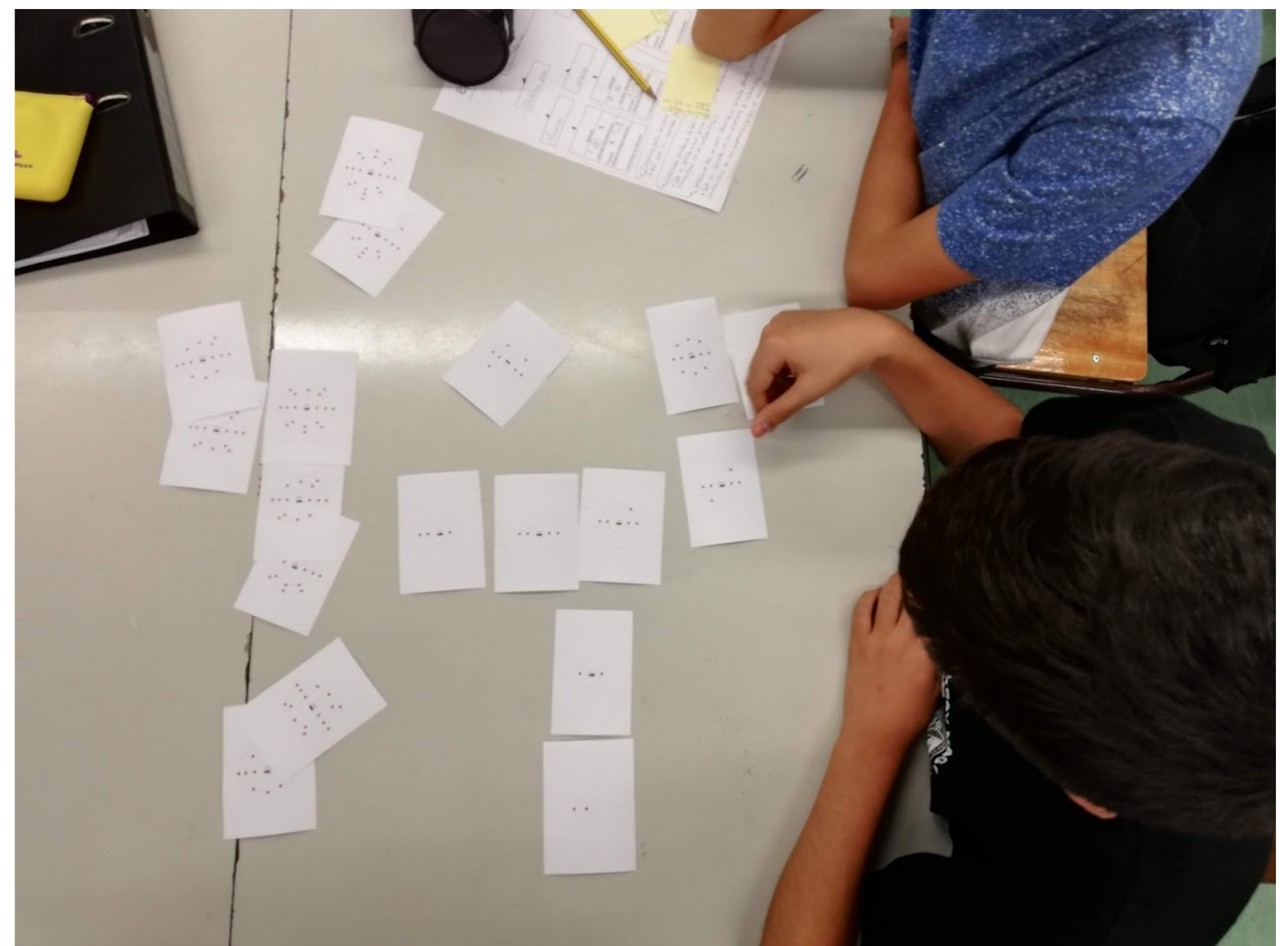
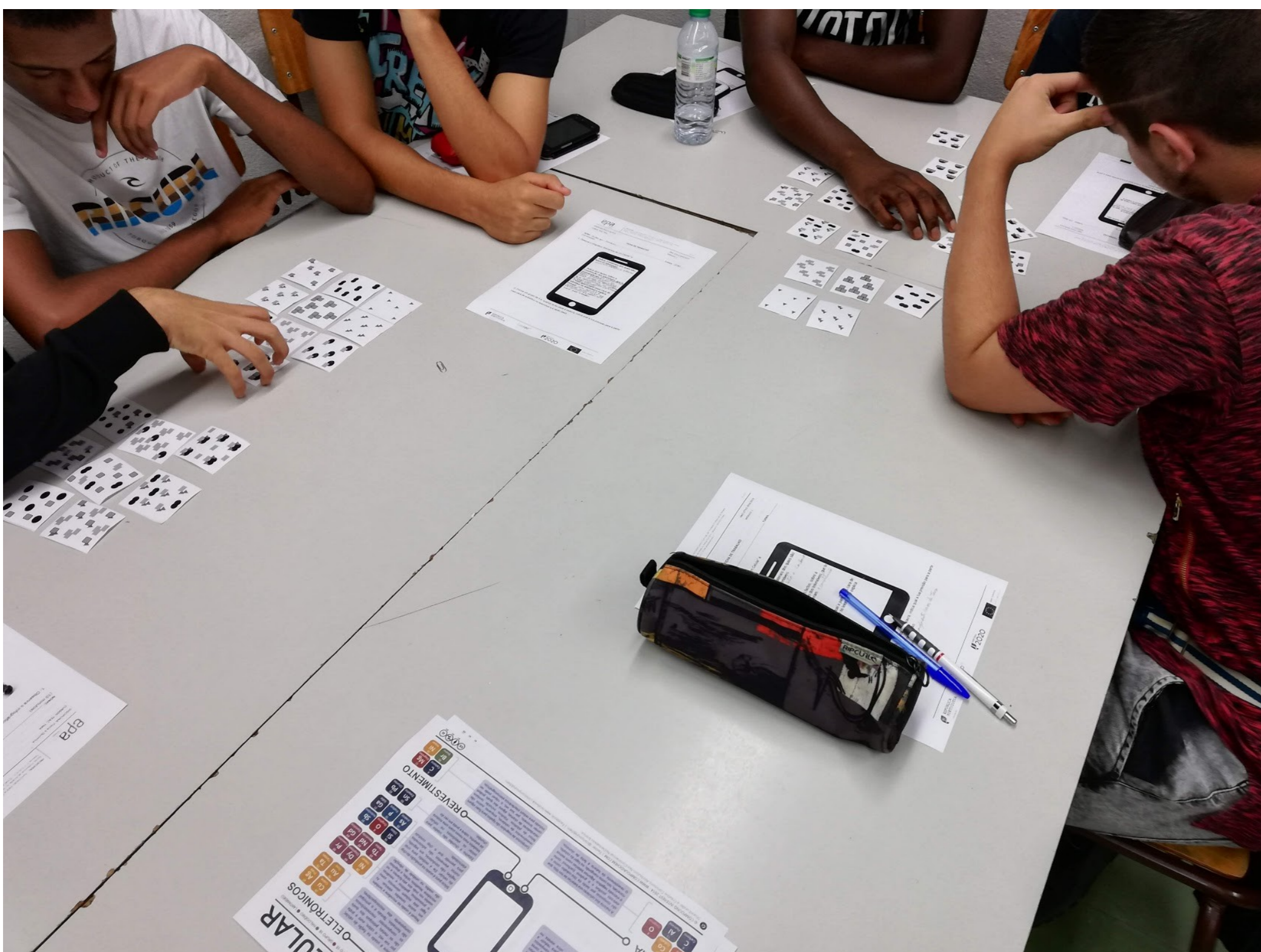
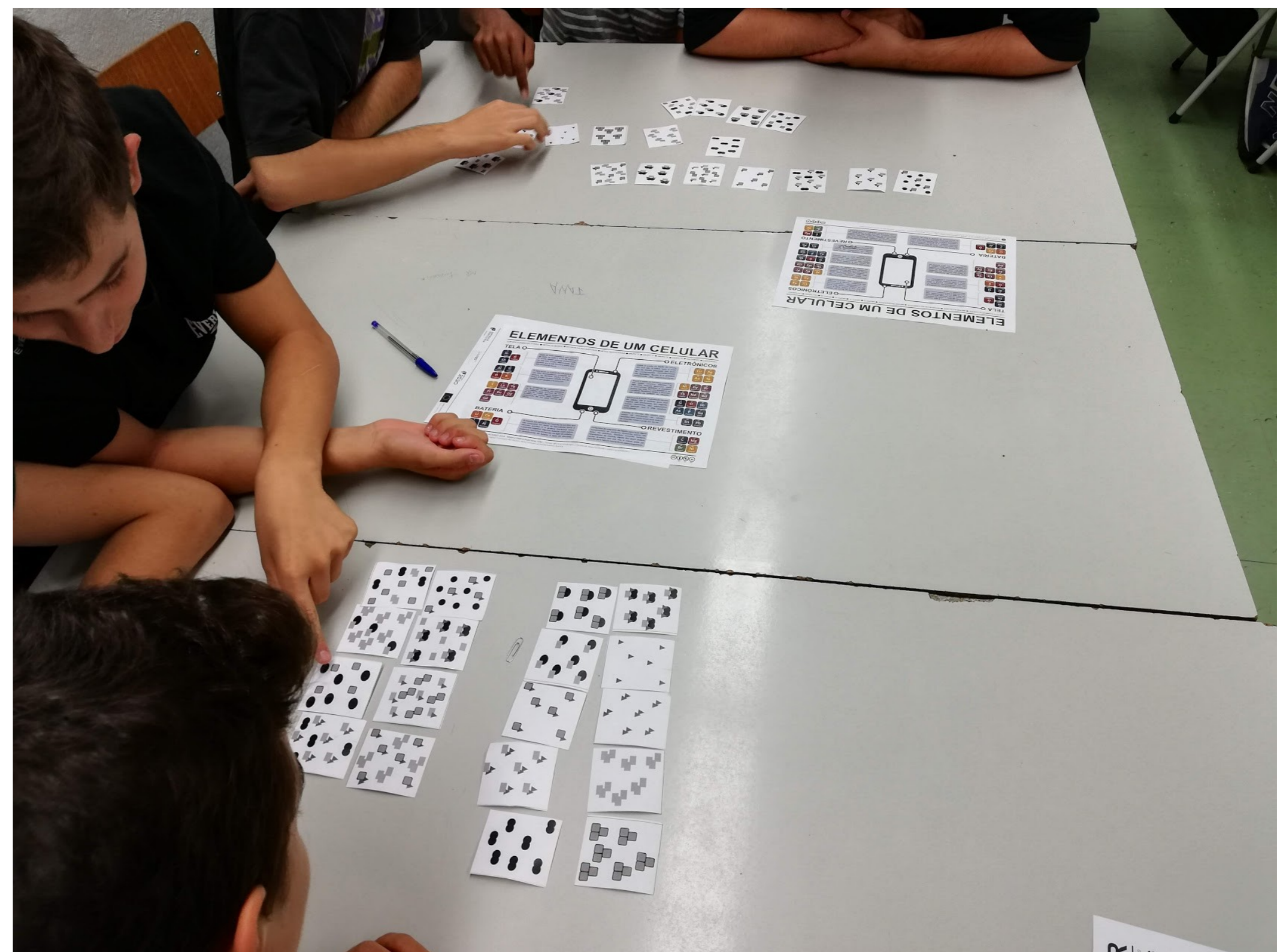

Learn what substances and mixtures are by using cards with images, reasoning and discussing ideas. Understand the organization of the Periodic Table and thereby the properties of the elements, by making predictions as Mendeleev did!!!

Slávka Ropeková | Základná škola, Nám. L. Novomeského 2 | Košice | SLOVAKIA

## Predict – Observe - Explain

The project presents ideas and techniques of a Science competition based on prediction of the results of the experiments from everyday life.

In the first part team of pupils is given a multiple choice question, they discuss it, **predict** the procedure of the given experiment and choose one answer. In the second part they set up the experiment and **observe** the result. In the end they compare their prediction with the result of the experiment and they try to **explain** it.

**What happens if we set an empty tea bag on fire?**

- a) *The tea bag burns with a green flame.*
- b) *The tea bag does not start burning.*
- c) *The tea bag rises into the air and starts flying.*

**What equipment do we need if we want to lift an iron nail up without touching it?**

- a) *a fork, a key, and a 4.5V battery*
- b) *one more iron nail and a 4.5V battery*
- c) *an iron bar, a wire, and a 4.5V battery*

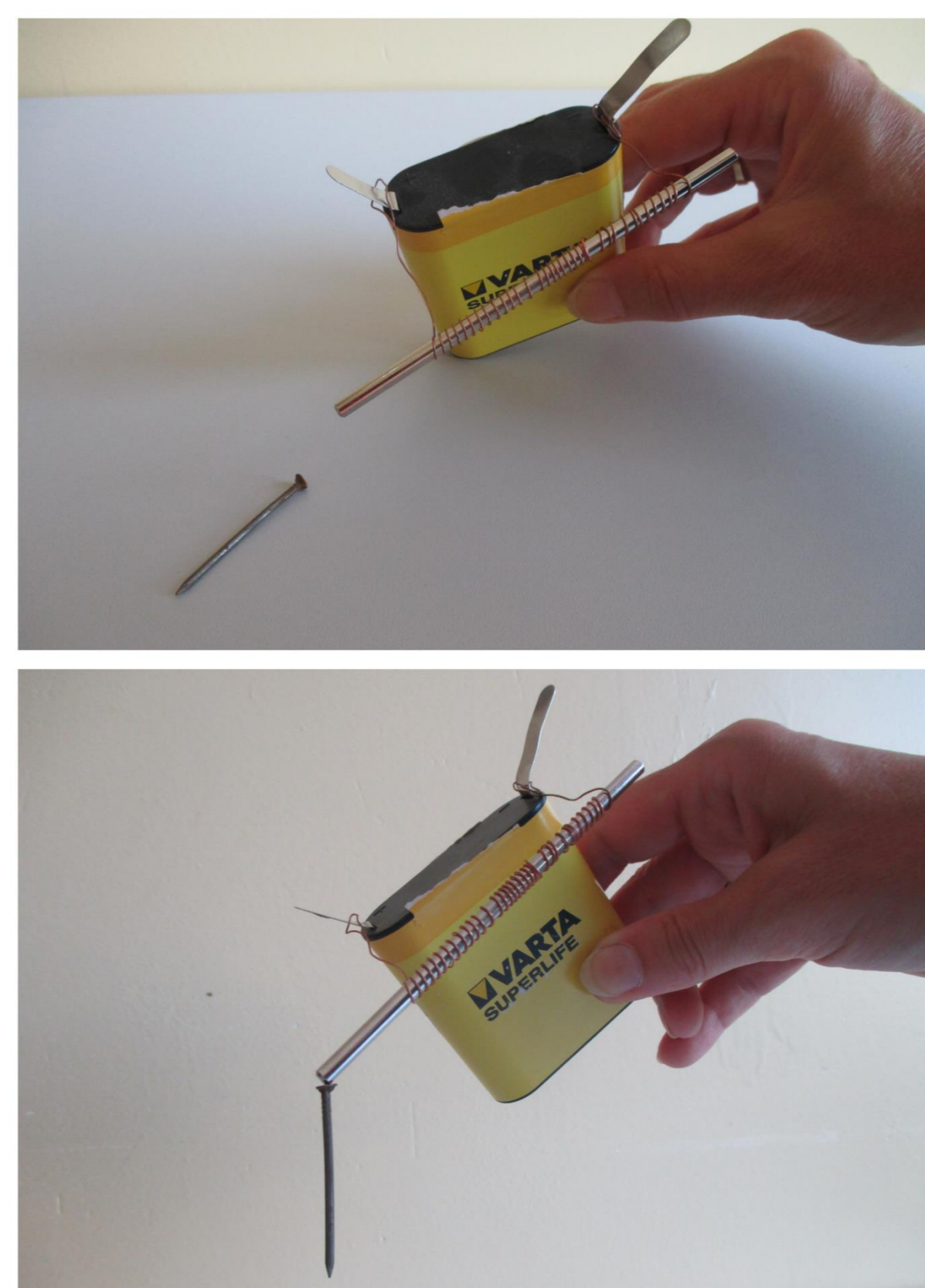
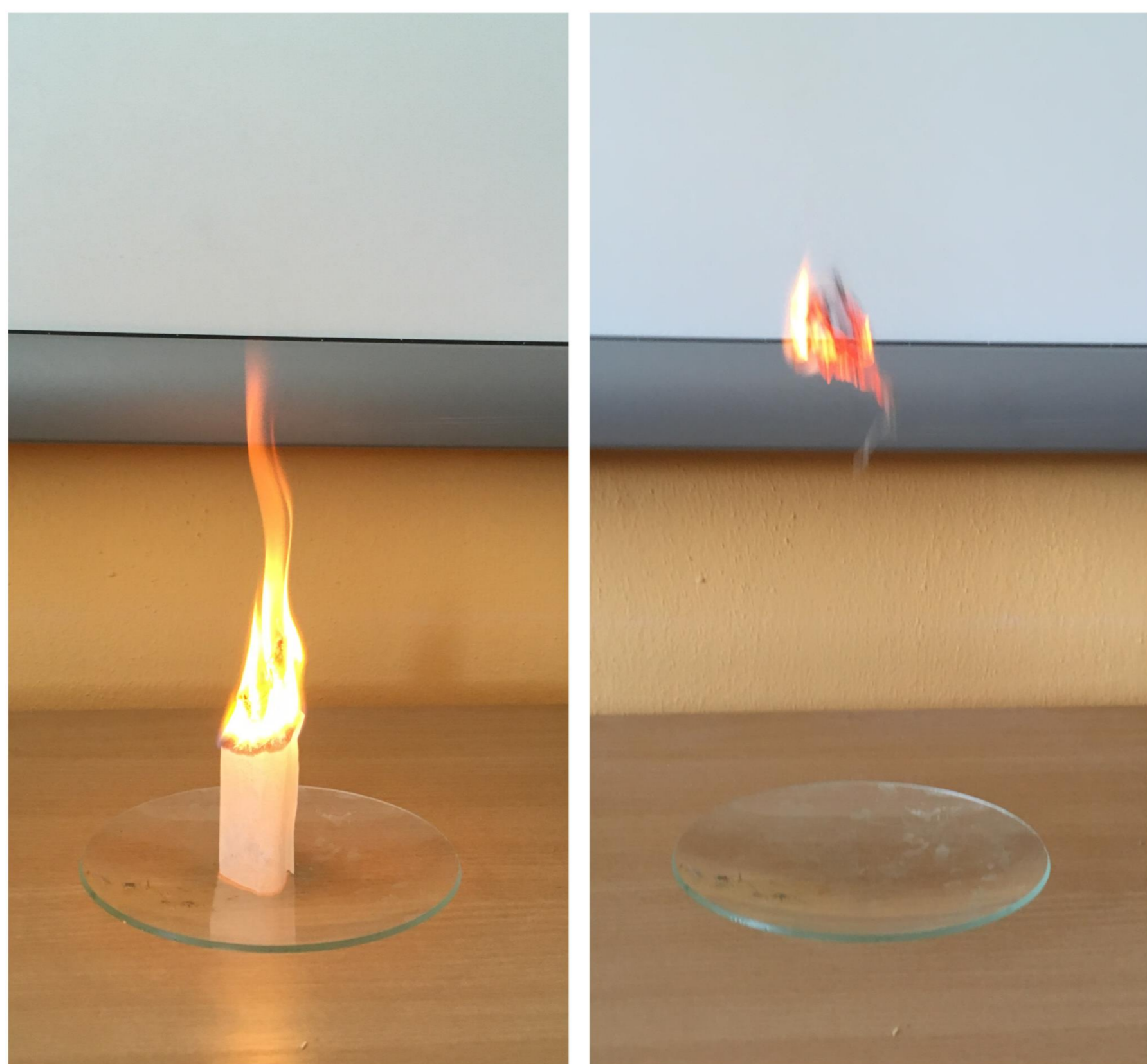

This competition aims to develop the pupils' skills to predict, reason, plan and conduct the experiment using low cost materials.